

# Integrating global issues in the creative English language classroom: With reference to the United Nations Sustainable Development Goals

Alan Maley and Nik Peachey



# **Integrating global issues in the creative English language classroom: With reference to the United Nations Sustainable Development Goals**

Alan Maley and Nik Peachey

ISBN 978-0-86355-855-9

© **British Council 2017**

10 Spring Gardens  
London SW1A 2BN, UK

**[www.britishcouncil.org](http://www.britishcouncil.org)**

# Teacher

## **What do you do?**

I'm a teacher.

## **What do you teach?**

People.

## **What do you teach them?**

English.

## **You mean grammar, verbs, nouns, pronunciation, conjugation, articles and particles, negatives and interrogatives ...?**

That too.

## **What do you mean, 'that too'?**

Well, I also try to teach them how to think, and feel – show them inspiration, aspiration, cooperation, participation, consolation, innovation,

... help them think about globalization, exploitation, confrontation, incarceration, discrimination, degradation, subjugation,

...how inequality brings poverty, how intolerance brings violence, how need is denied by greed, how –isms become prisons, how thinking and feeling can bring about healing.

**Well I don't know about that.**

**Maybe you should stick to language, forget about anguish.**

**You can't change the world.**

But if I did that, I'd be a cheater, not a teacher.

*Alan Maley*

# Contents

Foreword .....	5
Introduction .....	7
About the editors.....	9
<b>1. Developing children’s understanding of the Global Goals.....</b>	<b>11</b>
Carol Read	
<b>2. End poverty in all its forms everywhere.....</b>	<b>21</b>
Sylvia Zabor-Zakowska	
<b>3. End hunger, achieve food security and improved nutrition and promote sustainable agriculture.....</b>	<b>29</b>
Linda Ruas	
<b>4. Ensure healthy lives and promote well-being for all at all ages.....</b>	<b>41</b>
Carmen Flores	
<b>5. Ensure inclusive and equitable quality education and promote lifelong learning opportunities for all.....</b>	<b>49</b>
Daniel Xerri	
<b>6. Achieve gender equality and empower all women and girls.....</b>	<b>57</b>
Jemma Prior and Tessa Woodward	
<b>7. Ensure availability and sustainable management of water and sanitation for all.....</b>	<b>65</b>
Wei Keong Too	
<b>8. Ensure access to affordable, reliable, sustainable and modern energy for all.....</b>	<b>75</b>
Phil Wade	
<b>9. Promote sustained, inclusive and sustainable economic growth, full and productive employment and decent work for all.....</b>	<b>83</b>
Nik Peachey	
<b>10. Build resilient infrastructure, promote inclusive and sustainable industrialisation and foster innovation .....</b>	<b>91</b>
Malu Sciamarelli	
<b>11. Reduce inequality within and among countries.....</b>	<b>105</b>
Alan Maley	
<b>12. Make cities and human settlements inclusive, safe, resilient and sustainable .....</b>	<b>115</b>
David Brennan	
<b>13. Ensure sustainable consumption and production patterns.....</b>	<b>121</b>
László Katona and Nora Tartsay	
<b>14. Take urgent action to combat climate change and its impacts.....</b>	<b>127</b>
Maria Theologidou	



<b>15. Conserve and sustainably use the oceans, seas and marine resources for sustainable development</b> .....	<b>137</b>
Jill Hadfield and Charlie Hadfield	
<b>16. Protect, restore and promote sustainable use of terrestrial ecosystems, sustainably manage forests, combat desertification, and halt and reverse land degradation and halt biodiversity loss</b> .....	<b>145</b>
Chrysa Papalazarou	
<b>17. Promote peaceful and inclusive societies for sustainable development, provide access to justice for all and build effective, accountable and inclusive institutions at all levels</b> .....	<b>157</b>
Rebeca Duriga	
<b>18. Strengthen the means of implementation and revitalise the global partnership for sustainable development</b> .....	<b>167</b>
Jennifer Verschoor and Anna Maria Menezes	
<b>19. Content and the Sustainable Development Goals: going beyond language learning</b> .....	<b>173</b>
Adrian Tennant	
<b>20. Using extensive reading creatively to raise awareness of issues of equality and justice</b> .....	<b>181</b>
Sue Leather	
<b>21. Storytelling for a better world</b> .....	<b>187</b>
David Heathfield	
<b>22. Using the Sustainable Development Goals in the EAP classroom</b> .....	<b>195</b>
Averil Bolster and Peter Levrai	





# Foreword

As a teacher and as a trainer I've always been keen to bring an educational dimension to my work. With English having no fixed subject matter, one of my aims has been to bring real-world issues into the classroom. At the same time, my students come to class expecting to have fun, and psychology also tells me that a positive environment is where learning happens most successfully. How then can I avoid the 'dark cloud' phenomenon: how can I engage my learners in meaningful discussion of issues that really matter while staying positive and not feeling weighed down by all the problems of the world? In addition, how can I do justice to the big issues facing humanity? How can I bring them into the classroom without trivialising them and turning them into five-minute activities? The present publication, from the British Council and edited by Alan Maley and Nik Peachey, suggests that the key lies in engaging the creative faculties of our learners. All the 22 sections put creativity at the service of education. The various tasks involve learners in making sense of infographics, creating a photo gallery, engaging in a simulated UN discussion, inventing a slogan for a piece of street art, writing their own poems and stories, designing sustainable homes and cities, and puzzling over the richness of life in a rainforest, to name but a few. Language aims are integrated with educational aims, for example students improve their presentation skills while at the same time learning about the vital role water plays in our lives.

The United Nations Sustainable Development Goals provide a clear framework for the book as the educational aims of each activity and lesson plan are aligned to one or several of the 17 goals. Can the vision for a better world agreed on by world leaders in 2015 be realised? At the moment, we live in an unjust world, and many of us lead unsustainable lifestyles. To make significant changes by 2030, we need to do a lot of unlearning. Business as usual is no longer an option, and neither is education as usual. This publication is an invaluable tool in showing English teachers worldwide how they can make a difference.

Teachers of English have been at the forefront of educational change in many parts of the world. 'Learner autonomy', 'groupwork', 'project work', 'communication tasks' are all predicated on a view of learning that sees students as active doers and thinkers, rather than passive recipients of knowledge. The present publication builds on such a view. Students are encouraged to ask their own questions, conduct surveys, carry out research and reflect on the kind of world they would like to live in. As the title of the final story under the storytelling section reminds us, the future is in our hands – as teachers of English we can make a difference with the classes we teach and the students we inspire.

**Margit Szesztay**  
IATEFL Vice-president



# Introduction

In 2015 the British Council published a collection of chapters on various aspects of creativity. It aimed to raise teachers' awareness of the key role creativity plays in language education by providing a large number of practical classroom activities at all levels. The volume was titled *Creativity in the English language classroom* and is still freely downloadable via <http://englishagenda.britishcouncil.org/continuing-professional-development/cpd-teacher-trainers/creativity-english-language-classroom>. So far, some 40,000 copies have been downloaded worldwide, which seems to testify to the rising interest in creative classroom practices among teachers.

This current volume is a follow-up to the first one. Like the earlier volume, it offers practical and creative language teaching ideas. It differs from the earlier collection in one important respect, namely by additionally focusing on the 17 United Nations Sustainable Development Goals (SDGs).

What are the SDGs? As a result of the Sustainable Development Summit held in September 2015, world leaders adopted a set of 17 United Nations Sustainable Development Goals (SDGs) with a total of 169 targets. These are designed to end poverty, fight inequality and injustice and tackle climate change by 2030. A complete list of the goals can be found at: <https://sustainabledevelopment.un.org/?menu=1300>

But why do this? What have the SDGs to do with language teaching? There are several intertwined answers to this question. A growing number of ELT professionals have come to believe that language teachers are more than just teachers of language. Through what they teach and their attitudes and practices, they have an enduring influence on the future attitudes and personalities of their students. As John Dewey put it:

Perhaps the greatest of all pedagogical fallacies is the notion that a person learns only what he (or she) is studying at the time. Collateral learning in the way of the formation of enduring attitudes may be more important than the lesson in geography or history (Ed: or language!) for these attitudes are fundamentally what count for the future.

There can now be no room for doubt that planet Earth is currently assailed by some potentially lethal problems. The scale of the impact of human intervention on the planet has recently been compared with previous geological periods – and given a name, 'the Anthropocene' (see references). The effect of massive industrial and technological expansion, combined with exponential population growth, has put the survival of our ecosystems in jeopardy. Furthermore, as competition for control of resources increases, so too does the potential for conflict, with all its dire implications for humanity.

Human impact has increased dramatically, yet human nature has not made comparable progress. Many of our present woes are directly attributable to greed, pride, self-interest, prejudice, aggression, indifference to the plight of others, and the long list of the more negative characteristics of humanity.

There are no quick-fix solutions to these problems. But many would argue that teachers have a major role to play in helping to change unhelpful mindsets, and in raising awareness of the problems and issues, rather than continuing to turn a blind eye to them. Hattie's (2008) research identifies the teacher as the most significant factor in the learning context. And this is particularly the case for teachers of language, who have an inherent interest in the international community.

The thrust of this book is also in line with the relatively recent interest in critical thinking and in so-called 21st-century learning. It meshes too with the rising numbers of schools using CLIL (content and language integrated learning), by offering content-related materials to work with. Furthermore, major teacher associations such as IATEFL's Global Issues SIG, TESOL's Social Responsibility Interest Section and JALT's Global Issues SIG, among others, have recognised the importance of these issues. We hope that this book will provide added impetus to these initiatives and will also draw attention to the many projects operating to reduce the negative impact of the areas covered by the SDGs, including the C group.

As in the earlier publication, we have tried to offer a balanced selection. The 22 chapters cover a wide range in terms of geography – from Greece to Brazil – age range – from young learners to mature adults – language level – from elementary to advanced – and educational context – from private language schools to state schools and universities. Roughly half the contributors are non-native speakers and over half are women.

The book opens with a chapter by Carol Read involving all 17 SDGs. Chapters 2–18 cover one, and sometimes more, of the SDGs in numerical order. There are then chapters which deal with one special area, such as extensive reading or storytelling, which can be applied across the range of SDGs and local contexts. The book closes with another chapter, by Averil Bolster and Peter Levrai, which also covers the whole range of SDGs.

Though most of the chapters deal with a single SDG, it is clear that there is a multitude of connections between these issues. Climate change has economic consequences, with effects on water supply and food, which in turn have nutritional and health implications, which may lead to mass movements of population, which lead to social unrest ... The chain of complex factors has many links. Nonetheless, there are advantages in focusing on single issues, as the UN tried to do in 2015.

Clearly, the book is not intended to be read or used sequentially. We hope that teachers will find sections most relevant to their interests and local circumstances and be able to select activities which best serve their students' needs.

**Alan Maley and Nik Peachey**

## References

- Bonneuil and Fressaz (2016) *The Shock of the Anthropocene*. New York and London: Verso Books.
- Emmott, S (2013) *10 Billion*. London: Penguin.
- Hattie, J (2008) *Visible Learning*. London: Routledge.
- Vince, G (2014) *Adventures in the Anthropocene*. London: Chatto and Windus.

## Links

- What is the Anthropocene and are we in it?  
<http://www.smithsonianmag.com/science-nature/what-is-the-anthropocene-and-are-we-in-it-164801414/>
- Welcome to the Anthropocene  
<http://www.economist.com/node/18744401>
- The C Group  
<http://thecreativitygroup.weebly.com/>
- CLIL (content and language integrated learning)  
<https://www.teachingenglish.org.uk/article/content-language-integrated-learning>
- Critical thinking  
<http://www.criticalthinking.org/pages/defining-critical-thinking/766>
- IATEFL Global Issues SIG  
<http://gisig.iatefl.org/>
- Global issues in language education - JALT Special Interest Group  
<http://gilesig.org/>
- TESOL's Social Responsibility Interest Section  
<http://www.tesol.org/connect/interest-sections/social-responsibility>
- Partnership for 21st Century Learning  
<http://www.p21.org/>

## About the editors

**Alan Maley** has been involved with English language teaching for over 50 years. He worked with the British Council for 26 years (1962–88) in Yugoslavia, Ghana, Italy, France, China and India. He then resigned to take over as Director-General of the Bell Educational Trust in Cambridge (1988–93).

He was Senior Fellow at the National University of Singapore (1993–98) before going on to set up a new MA programme at Assumption University, Bangkok (1999–2004). He has since held university positions in Malaysia and Vietnam.

He is now a freelance trainer, writer and consultant. He has published over 50 books and numerous articles. He is a past President of IATEFL and recipient of the ELTons Lifetime Achievement Award (2012). He is also a co-founder of the C Group (<http://thecreativitygroup.weebly.com>). In 2015 he co-edited, with Nik Peachey, the highly successful companion volume to this book – *Creativity in the English language classroom*.

**Nik Peachey** is a freelance teacher trainer, writer, conference speaker and learning technology consultant. He has been involved in education since 1990 and has lived and worked all over the world. He is a two-time British Council Innovations Award winner and the co-founder of PeacheyPublications.com.

He has worked with a wide range of educational companies, publishers and institutions, including Macmillan, Cambridge University Press, Oxford University Press, The British Council, International House, Bell Educational Services, University of Westminster, The Open University, BBC, Google Creative Labs and many more.

Nik is a keen blogger and content curator. You can find his blogs at: <https://nikpeachey.blogspot.co.uk/> and <http://quickshout.blogspot.co.uk/> and his curation sites at: <http://www.scoop.it/t/tools-forlearners> and <http://www.scoop.it/t/learningtechnology>

He also publishes a twice-monthly Learning Technology and ELT newsletter at: <https://tinyletter.com/technology/>

In 2015 he co-edited, with Alan Maley, the highly successful companion volume to this book – *Creativity in the English language classroom*.



# 1

## Developing children's understanding of the Global Goals

Carol Read

### Introduction

This chapter aims to develop upper-primary and lower-secondary children's awareness and understanding of the Global Goals. It describes a child-friendly approach that integrates language learning, creative thinking and social responsibility in a way that enables children to relate key issues to their own lives. It also lays solid foundations for children becoming responsible, global citizens in the future.

We currently live in an age where, in many different countries and contexts, a standardised approach to schooling, including ELT, is increasingly the norm. This is typically characterised by low-risk, discrete-item teaching, frequent testing and dependence on measurable results and outcomes. By introducing children to the Global Goals as part of foreign language lessons, we can redress this balance and integrate a more holistic, personalised approach to children's education into our classroom practice. In addition to developing specific areas of children's English vocabulary and language skills in a worthwhile, motivating and enjoyable way, there are a number of other potential far-reaching benefits. These include:

- raising awareness of global issues that touch children's lives, no matter where they live.
- empowering children with language to talk about such issues in a confident way.
- developing critical thinking and problem-solving skills through enquiry-based discussion.
- developing social skills such as listening, turn-taking, sharing ideas and co-operating with others in order to carry out activities.
- fostering positive attitudes such as tolerance and respect for the views of others.
- encouraging the belief that it is the responsibility of everyone to meet the Global Goals and that by working together this is more likely to be achievable.

- providing opportunities for children to think 'out of the box' and come up with their own creative ideas, designs, products and solutions.
- integrating values which help to promote reflective thinking, responsible choices and principled behaviour.

The practical activities and lessons that follow focus on all 17 Global Goals and are designed for use with children between the ages of approximately 10 and 14 years, with a minimum English language level of A2. However, some of the activities may also be suitable to use with older students when introducing the concept of the Global Goals for the first time. The overarching objectives of the activities and lessons are to develop, at an appropriate level of linguistic and cognitive challenge, children's awareness and understanding of:

- i) the broad scope of the Global Goals and the social and environmental issues and themes they cover.
- ii) the connections and links between the Global Goals in terms of problems and solutions.
- iii) how the Global Goals relate to children's immediate home and school environment as well as to their local region or country.
- iv) positive action and things children can do themselves to help achieve the Goals.

Although the activities and lessons are freestanding, you may decide to teach all of them chronologically. In this case, you will find that together they constitute a topic-based unit of work on the Global Goals. This provides a coherent sequence and logical progression, leading children from an initial understanding of the names and aims of the Goals to a final outcome in which they carry out a project based on helping to achieve one of the Goals in their local context.

## Activities

### Activity 1: Discover and prioritise the Global Goals

#### Aims

- To introduce the names and aims of the Global Goals
- To prioritise the Global Goals and justify choices

#### Language Focus

- Naming and talking about the Global Goals, e.g. What's the aim of this goal?
- To ensure (that) ...; I think Goal ... is a top priority because ...

#### Creative Focus

- Thinking creatively and critically to justify choices

Level A2+  
Age 10–14  
Time 60 minutes

#### Preparation

- Select, download and be ready to project photos from Global Goals Imagery provided by Getty Images: Global Goals Resource Centre – <http://www.globalgoals.org/resource-centre/the-basics/>
- One copy of 'Global Goals – names and aims' worksheet – Materials – cut into strips for each student; scissors, glue

#### Procedure

- Ask students what they think are the biggest problems in the world today. Listen to their ideas and project photos you have prepared to stimulate their thinking. Use the photos and students' suggestions to pre-teach key vocabulary, e.g. poverty, health, hunger, war.
- Explain that the Global Goals are internationally agreed objectives to build a better world for all people and for our planet by 2030 in a way that is sustainable, i.e. that respects resources and the environment and will last into the future.
- Explain that there are 17 different Global Goals and give examples, e.g. No poverty, No hunger.
- Students work in pairs and predict other Global Goals.

- Students report back. Use their responses to introduce the Global Goals. Explain new concepts and vocabulary as necessary and check understanding.
- Compare the Goals with students' predictions.
- Give one strip of paper from the single copy of the worksheet to each student (or pair, depending on the size of your class) in random order.
- Explain that on the left of the strip is the name and number of one of the Goals and on the right is the aim of a different Goal.
- Explain and demonstrate that one student should start by reading out the number and name of the Goal on their strip (avoid starting with Goal 1) and ask 'What's the aim of this Goal?' The rest of the class (except the student who can identify the answer on their strip) should suggest answers starting 'To ensure ...'
- The student who has the answer on their strip then reads it to the class and has the next turn at naming a Goal and asking the aim in the same way. Be ready to check comprehension and clarify meaning as necessary. The activity continues until all the Goals and aims have been named.
- Give one copy of the worksheet to each student. Have scissors and glue available. Students cut out the names of the goals and aims.
- Explain that students should work in pairs and choose three Goals that they personally think should be top priority and stick them (with the corresponding aims) in order in their notebooks. Ask them to be ready to give reasons for their choice, e.g. 'We think Goal 16 is a top priority because war destroys homes and kills people. People can't work or earn money. Children can't go to school. There is often no food or clean water.'
- Pairs take turns to report back, giving reasons to justify their choices.
- Keep a record on the board of the Goals chosen by each pair. At the end of the activity, count up to see the class's top three Global Goal priorities.
- Finish by briefly getting students to review what they have done and learned.



## Materials

Global Goals – names and aims

Goal 1: No poverty	To ensure that countries and organisations work together to achieve the goals
Goal 2: No hunger	To ensure that everyone has enough money to live
Goal 3: Good health	To ensure that everyone has enough food to eat
Goal 4: Quality education	To ensure that everyone has the right to medical care
Goal 5: Gender equality	To ensure that everyone has the opportunity to go to school
Goal 6: Clean water and sanitation	To ensure that girls and women have the same rights and opportunities as boys and men
Goal 7: Renewable energy	To ensure that everyone has safe water and healthy hygiene
Goal 8: Good jobs and economic growth	To ensure that everyone has access to reliable, sustainable energy
Goal 9: Innovation and infrastructure	To ensure that everyone has the opportunity to work
Goal 10: Reduced inequalities	To ensure that industry is responsible in protecting people and the environment
Goal 11: Sustainable cities and communities	To ensure that countries have laws and societies that protect everyone equally
Goal 12: Responsible consumption	To ensure that cities, towns and villages have water and electricity, and are clean and safe
Goal 13: Climate action	To ensure the reduction of waste, for example by recycling paper or glass
Goal 14: Life below water	To ensure action to slow down the impact of global warming
Goal 15: Life on land	To ensure action to protect oceans and seas
Goal 16: Peace and justice	To ensure action to protect the environment and endangered animals
Goal 17: Partnerships for the Goals	To ensure the end of violence and war and give everyone access to justice

### Follow-up

- Students stick the remaining 14 goals and aims in their personal order of priority in their notebooks. Students compare and discuss the order, giving reasons for their choices.

### Answer key

On the worksheet, the aim of each Goal is on the next strip, i.e. the aim of Goal 1 is on the strip with Goal 2. The aim of the last Goal is on the strip with Goal 1.

### Additional resources

World's Largest Lesson – The World We Want

- This child-friendly booklet has illustrative stories and more details about the aims and plans to achieve each Global Goal. [http://cdn.worldslargestlesson.globalgoals.org/2016/05/The-World-We-Want-Double-Page-Booklet-style\\_HiRes\\_English.pdf](http://cdn.worldslargestlesson.globalgoals.org/2016/05/The-World-We-Want-Double-Page-Booklet-style_HiRes_English.pdf)

## Activity 2: Global Goal icons

### Aims

- To create and design an icon for one or two of the Global Goals
- To plan what you can do to achieve the Goals at home and school

### Language focus

- Expressing opinions and likes, e.g. I think this icon is ... / I like this icon because ... / My favourite icon is ...; talking about what you can do, e.g. I think we can ... / should ... / Great idea! I agree.

### Creative focus

- Experimenting with creative visual design

Level A2+  
Age 10–14  
Time 60 minutes

### Preparation

- Be ready to project the official Global Goal icons: World's Largest Lesson – The Global Goals: [http://cdn.worldslargestlesson.globalgoals.org/2016/07/150902B\\_TheGlobalGoals\\_Logo\\_and\\_Icons\\_Newversion\\_edited\\_11.09.15ai-2.jpg](http://cdn.worldslargestlesson.globalgoals.org/2016/07/150902B_TheGlobalGoals_Logo_and_Icons_Newversion_edited_11.09.15ai-2.jpg)
- Have one or two pieces of paper for each pair, rulers, felt tips or crayons.

### Procedure

- Challenge the class to recall the 17 Global Goals if they are already familiar with them. If not, introduce the Goals.
- Introduce students to the concept of an icon, using ones that are typical in their context, e.g. icons for toilets or road signs.
- Discuss what they think makes a good icon, e.g. simple, clear, direct, easy to understand, attractive, memorable.
- Divide the class into pairs. Give one or two sheets of paper to each pair. Have rulers and felt tip pens or crayons available.
- In pairs, students use a ruler to draw one or two squares (10cm x 10cm) and create and design an icon for one or two Global Goals. These can be icon(s) either that you select or of their choice (but tell them to keep this 'secret' for now). If you like, set a time limit, e.g. 10 minutes.

- When they are ready, students take turns to show their icon(s) to the rest of the class who guess the Global Goal it represents, e.g. 'I think it's "Life below water".' 'You're right!' / 'No, it isn't. Guess again!'
- Stick all the students' icons on the board. Encourage them to say what they like about the different icons and why, e.g. 'I like the rhino and the elephant for "Life on land". It's attractive and clear.'
- Optionally, organise a class vote to decide which is the class's favourite icon.
- Project the official Global Goal icons. Students compare these with the icons they have designed and talk about the ones they like best.
- Ask students to work with their partner and think of things they can do to help achieve the Goals at home and in school, e.g. always put litter in the bin; wash hands before meals and after going to the bathroom; turn off lights and taps when you're not using them; use recycled paper; save water by having showers instead of baths; walk, cycle or use public transport to go to school.
- Pairs take turns to report back and share their ideas.
- Finish by briefly getting students to review what they have done and learned.

### Follow-up

- Students make a collective book or poster (either digital or print) of the Global Goal icons they have designed together with a bullet-pointed list of 'Our ideas for achieving the goals at home and school'. This can be displayed either in the classroom or on a class blog or wiki.

### Additional resources

YouTube – Mr Bean and the Global Goals

- This is a short animated film showing Mr Bean's humorous attempts to spread the word about the Global Goals: <https://youtu.be/s8cWM-TFZwM>

### Activity 3: Create and play Global Goal games

#### Aims

- To create a card or board game based on the Global Goals
- To explain and play each other's games

#### Language focus

- Playing games, e.g. It's my/your turn. / Put the cards face up/down. / Throw the dice. / Move the counter. / I'm/You're the winner.

#### Creative focus

- Inventing and designing a game

Level A2+  
Age 10–14  
Time 60 minutes

#### Preparation

- Download and make copies of the Global Goal icons and cut them into sets of cards (one set for each student): [http://cdn.worldslargestlesson.globalgoals.org/2016/07/150902B\\_TheGlobalGoals\\_Logo\\_and\\_Icons\\_Newversion\\_edited\\_11.09.15ai-2.jpg](http://cdn.worldslargestlesson.globalgoals.org/2016/07/150902B_TheGlobalGoals_Logo_and_Icons_Newversion_edited_11.09.15ai-2.jpg)
- You'll need large sheets of card, glue, counters, dice.

#### Procedure

- Give a set of Global Goal cards to each student.
- Explain, demonstrate and get students to play one or more well-known games with their sets of cards as below (Bingo, Memory and Snap). Use the games as an opportunity to pre-teach or remind students of language for playing games.

##### Bingo

Students choose ten cards and lay them out face up on their desks. Name the Global Goals in random order. Students listen and turn over the cards if they have the Goals you name. The first student to turn over all their cards says 'Bingo!' and is the winner.

##### Memory

In pairs, students lay out two sets of cards face down in random order on their desks. Students take turns to turn over two cards and name the goals. If the cards are a pair, they take them and have another turn. If not, they turn them back in exactly the same place. The student with most cards at the end of the game is the winner.

##### Snap

In pairs, students put their cards face down in a pile. They turn over the cards one by one at the same time and name the Goals. As soon as their two cards have matching Goals, the first student to say 'Snap' wins the cards. The student with most cards at the end of the game is the winner.

- Explain that students should work with their partner and create a new game either using the Global Goal cards or making them into a board game.
- Elicit or suggest the names of familiar games that might give students ideas for their games, e.g. Happy Families, Snakes and Ladders, Top Trumps, Ludo, Trivial Pursuit. Have ready large sheets of card, glue, counters and dice if students choose to make a board game.
- Students work together and create a game. They invent the rules and think of a name for their game, e.g. Global Goal Track – a board game played with dice and counters with squares consisting of Global Goals and other instructions such as 'Miss a go!', 'Go to Goal 11', 'Have another turn'. As part of the rules, students might invent that players have to, for example, say the aim of the Goal, or name one problem, or suggest a solution, or something they can do to achieve the Goal, for each Goal they land on.
- Pairs make groups of four and take turns to explain and play each other's games.
- Students report back to the class on the games they have played.
- Finish by briefly getting students to review what they have done and learned.

#### Follow-up

- Plan to leave 10–15 minutes at the end of subsequent lessons for students to take turns to play each other's games, with the pair who created the game introducing and explaining it each time.

#### Additional resources

World's Largest Lesson – Teaspoons of Change Global Goals

- This game is based on collecting 'teaspoons of change' by doing a series of actions over time to achieve all 17 Global Goals. The whole class or school can play the game collectively. <http://cdn.worldslargestlesson.globalgoals.org/2016/09/Global-Goals-Bingo.pdf>

## Activity 4: Global Goal themes and drama 'still life'

### Aims

- To classify the Global Goals into six themes
- To create 'still life' drama scenes to convey the themes

### Language focus

- Expressing opinions, e.g. I think ... goes here. / I think it's important that ... because ... / I think your scene shows the theme '...' / I like it because ...

### Creative focus

- Thinking creatively and critically in relation to the Global Goals and themes; using drama to convey the themes

Level A2+  
Age 10–14  
Time 60 minutes

### Preparation

- Download copies of Global Goal icons and cut them into sets of cards (one for each student) or reuse the cards you prepared for the previous activity: [http://cdn.worldslargestlesson.globalgoals.org/2016/07/150902B\\_TheGlobalGoals\\_Logo\\_and\\_Icons\\_Newversion\\_edited\\_11.09.15ai-2.jpg](http://cdn.worldslargestlesson.globalgoals.org/2016/07/150902B_TheGlobalGoals_Logo_and_Icons_Newversion_edited_11.09.15ai-2.jpg)
- Download and make copies of one set of individual class-size Global Goal icons to use on the board: Goals Resource Centre – <http://www.globalgoals.org/resource-centre/the-basics/>
- Prepare six global theme cards with text as below in large-size font.

### Procedure

- Review the Global Goals in a team game. Say the letters of the alphabet in random order. Students take turns to respond with keywords relating to the Global Goals and score points for their team, e.g. P! / Poverty / Peace; E! / Education / Energy; H! Health / Hunger.
- Divide the class into pairs. Give one set of small Global Goal cards to each pair.
- Name the Global Goals in turn and children hold up the correct cards.

- Explain that the Global Goals can be classified into six general themes. Stick the Global Goal theme cards in a row on the board. Read them and check understanding as you do this:
  1. Everyone has enough money to live.
  2. People are fit and well.
  3. There are opportunities to learn and work.
  4. The world is safe and fair.
  5. The environment is protected.
  6. Our way of life is sustainable.
- Explain that the pairs should work together and classify the Global Goals by grouping the cards on their desks into the six themes above. Demonstrate what you mean and give, or elicit, one or two examples, e.g. 'People get ill if they drink dirty water, so I think Goal 6 (Clean water and sanitation) goes here (under number 2).'
- Monitor students as they work. Be ready to prompt, help and encourage as necessary.
- When students are ready, check the answers by inviting individual students in turns to come to the front of the class and stick the class-size Global Goal icons under the correct theme cards on the board. Encourage children to give reasons as they do this, e.g. 'I think Goal 5 (Gender equality) goes here (under number 4) because it's fair that boys and girls are equal.' Check that other children in the class agree.
  - o **Answer key:** theme 1 = Global Goals 1,10; theme 2 = Global Goals 2, 3, 6; theme 3 = Global Goals 4, 8; theme 4 = Global Goals 5, 16; theme 5 = Global Goals 7, 9, 11, 12, 17; theme 6 = Global Goals 13, 14, 15.
- Ask students which themes they think are most important. Listen to their responses and reasons, e.g. 'I think it's important that everyone has enough money because ...' Be ready to support students in expressing their meaning and recast and expand their answers as appropriate.
- Ask further questions about, for example, the theme that children think affects their city, region or country most, the theme that they think is easiest/hardest to achieve, the theme that they think they can personally do something/nothing about. Use the discussion to expand students' understanding of the broad themes of the Global Goals and to relate the Goals to their own lives. Show that you value their personal, divergent views.

- Divide the students into six groups. Give each group one of the Global Goal theme cards without others in the class seeing. Ask them to keep it a 'secret'.
- Explain that students are going to do a drama activity and that each group should work together and create a 'still life' scene that conveys the theme on their card. Demonstrate that children should be ready to 'freeze' in position as part of their group's scene. (These are sometimes called 'tableaux')
- Give a time limit, e.g. 3–5 minutes, for students to prepare their scenes.
- When they are ready, students take turns to show their 'still life' scenes to the rest of the class and guess the themes. Invite children to comment positively on aspects of the 'still life' scenes that they like and feel convey the theme most effectively.
- Finish by briefly getting students to review what they have done and learned.

### **Follow-up**

- Students use the small sets of Global Goal cards to classify the Global Goals on their desks in other ways of their choice, e.g. Goals that they think are very relevant/quite relevant/not relevant to their city, region or country. Children then look at each other's classifications and try and deduce the criteria used.

### **Additional resources**

YouTube – Numbers in Action

- This is a short animated film set to a catchy, rhythmic rap which shows the progress in numbers in tackling selected Global Goals and what still needs to be achieved by 2030. [https://www.youtube.com/watch?v=Mdm49\\_rUMgo](https://www.youtube.com/watch?v=Mdm49_rUMgo)

## Activity 5: Global Goal connections and Project Action Plan

### Aims

- To explore connections between Global Goals
- To make an action plan to achieve one Global Goal (leading to a project)

### Language focus

- Talking about causation, e.g. If ..., then ...; making suggestions, e.g. Let's ... / What about ...? / Why don't we ...?

### Creative focus

- Thinking creatively and critically to establish links between Global Goals; brainstorming ideas for a plan of action (leading to a project)

Level A2+  
Age 10–14  
Time 60 minutes

### Preparation

- Make copies of Global Goal icons cut into sets (as in the earlier activities); large sheet of card (one for each group), (optional) coloured straws or pipe cleaners.

### Procedure

- Divide the students into groups. Give each group a set of Global Goal icons, a large piece of card, glue and (optionally) coloured straws or pipe cleaners.
- Students stick the icons (spaced out in any position or order) on the card.
- Explain and demonstrate that students should take turns to draw lines (or stick coloured straws or pipe cleaners) to create a spidergram showing connections between the Global Goals and give reasons as they do this, e.g. 'If children are hungry (Goal 2), then it is difficult for them to concentrate and learn at school (Goal 4).' / 'If people don't have jobs (Goal 8), they are poor (Goal 1).' / 'If there isn't clean water to drink (Goal 6), people get ill (Goal 3).' If you like, set a time limit for this, e.g. 15 minutes.
- Groups take turns to report back and compare the Global Goal spidergrams they have created.
- Use the results to talk about how global problems and solutions are linked.
- Ask the groups to choose one Global Goal and brainstorm ideas for an action plan (in English or their own language) of what they can personally do to help achieve the Goal. Elicit ideas for one Goal as an example, e.g.



- Students work together and make their plans. Set a time limit for this, e.g. 15 minutes.
- Groups take turns to present and comment on each other's ideas and plans.
- Ask the groups to decide which of their ideas they would like to act on as a project (possibly working on one idea each in pairs).
- Finish by briefly getting students to review what they have done and learned.

### Follow-up

- Get students to make a detailed plan for their project. Establish a timeline and success criteria for the projects. The projects can be carried out as part of several subsequent lessons and/or at home.

### Additional resources

YouTube – Emma Watson Introduces the World's Largest Lesson 2016

- This is a short film showing inspiring, animated stories of children's creative achievements to meet the Global Goals in different countries. <https://youtu.be/-cEUhHTlcDU>

World's Largest Lesson – Elif Bilgin, Turkey

- This document has photos and real-life stories of the children in the 'World's Largest Lesson 2016' animated film and an invitation to children everywhere to be part of the action. <http://cdn.worldslargestlesson.globalgoals.org/2016/08/Changemakers-Take-Action2.pdf>

## Conclusion

The future of our planet is in the hands of today's children. By developing children's awareness and understanding of the Global Goals through engaging and creative activities, it is hoped that they will not only enrich their vocabulary and enhance their English language skills in a meaningful, creative and memorable way but also develop interest, concern, motivation and a sense of social responsibility for major issues facing all people and our planet today.

## Further resources

Centre for International Sustainable Development Law (CISDL) – 2015

- This statement was made by children at the Children's Summit, New York, USA, in September 2015 as principle stakeholders in global decisions, and can be inspiring to share with children (B1/2).

Enchanted Learning – World Environment Day Crafts and Projects

- This is a subscription site but also has a lot of free ideas and activities for celebrating World Environment Day (5 June) with younger children (A1/2).  
<http://www.enchantedlearning.com/crafts/wed/>

Global Goals Resource Centre

- This site has a wide range of freely downloadable resources as well as links to images and films related to the Global Goals. <http://www.globalgoals.org/resource-centre/the-basics/>

Onestopenglish – Amazing World of Animals

- This is a subscription site with a project on wild animals for young learners, including an understanding of animal habitats and why some animals are in danger (A1/2). <http://www.onestopenglish.com/clil/young-learners/animals/project-amazing-world-of-animals/>

Onestopenglish – Amazing World of Food

- This is a subscription site with a project on food for young learners, including an understanding of responsible consumption and basic issues related to world hunger (A1/2).

TeachingEnglish – Promoting Diversity Through Children's Literature

- This site gives you access to freely downloadable materials based on eight picture books suitable for children which develop awareness and understanding of issues related to the Global Goals, such as equality, inclusion, racism, recycling, climate and responsible consumption (A1/2).  
<http://tinyurl.com/z9pzj7n>

World's Largest Lesson

- This site is a fantastic treasure trove of freely downloadable resources and information for educators working with young people on the Global Goals. The site includes booklets, fact sheets, lesson plans, stories and comics as well as videos and animated cartoons, some of which are either suitable or can be adapted to use in the ELT classroom with children (A2+).  
<http://worldslargestlesson.globalgoals.org/>





# 2

## Sustainable Development Goal 1: End poverty in all its forms everywhere

Sylwia Zabor-Zakowska

### Introduction

We live in a world of contrasts. According to Oxfam International, inequality between rich and poor has grown at an alarming rate. The annual income of the wealthiest people of the world would be enough to end extreme poverty – but still more than a billion people suffer and die from hunger and disease because they cannot afford vaccination and live in humiliating conditions of poverty with no water or electricity. This burning problem obviously concerns developing countries primarily. However, it is not unusual to find homeless people in much wealthier parts of the globe too. Furthermore, the situation is harmful not only to the poorest but has a negative impact on us all.

Apart from NGOs like Oxfam, other international organisations such as the UN and UNICEF persistently fight to reduce poverty. Education transforms lives and sits 'at the heart of UN's mission to build peace, eradicate poverty and drive sustainable development'. In some countries, like my country, Poland, there is also co-operation with schools, organisations and companies.

I have personally experienced a transformation in my country from communism to democracy. I grew up in a country where food and other goods were rationed and where there was a 'curtain' we were not allowed to go through to see and experience a better world. Nowadays, my children grow up in a free country and learn in international schools. I wish all the children around the world could live in such good conditions. I know that the power of creativity as well as a good command of English are vital to achieve this.

In this chapter I will address SDG 1 of the UN's Sustainable Development Goals, and will connect it with fostering creativity and teaching English. I have developed a project based on the elements of varied forms of art, examples of outstanding and inspirational creativity in poor regions of the globe and the elements of CLIL. Apart from creative language activities, I have introduced craft activities and elements of creativity training (Nęcka, 1992).

I deeply believe that, through education, we can shape empathy and creativity in our students – crucial factors to help others and to overcome difficulties (Kapuściński, 2004, 2008). Making use of art in teaching a language gives us an even better chance of success, since art is a universal means of communication between people, whatever their origin or social status.

As I specialise in creative teaching to children, I have prepared all the activities for 8- to 10-year-olds at B1 level. I have often experienced that children discuss serious issues eagerly. I am sure, though, that creative teachers will easily adapt them for other levels or groups. Creative, non-conventional lessons are still needed by teenagers and adults too.

I decided to use mostly recyclable and natural materials so as to replicate the situation many poorer people would find themselves in. This will also make the project more credible and practicable in low-resource school contexts. Last but not least, it will encourage students to collect recyclables for the classes and thus raise their awareness of these issues.

### Activity 1: Global Goal icons

#### Aims

- To raise the awareness of the phenomenon of poverty on the globe
- To reflect on material and non-material needs

#### Language focus

- Learning vocabulary of values, needs and possessions
- Learning the language of co-operation and sharing

#### SGD focus

- SDG 1 No poverty – To research new ways to shape learners' empathy and sensitivity to other people's needs

## Creative focus

- Preparing elements for collages to develop students' symbolic thinking
- Generating lots of ideas to facilitate fluency, flexibility and originality of thinking

Level B1

Age 8–10 years

Time 3 lessons (approx. 135 minutes)

## Preparation

- Photographs from National Geographic – Photographers capture the gap between the rich and the poor: [http://yourshot.nationalgeographic.com/tags/rich\\_and\\_poor/](http://yourshot.nationalgeographic.com/tags/rich_and_poor/)  
The short text under each photo introduces viewers to the context.
- You will also need paper, crayons, a big sheet of recycled paper, old glossy magazines, glue, scissors.

## Procedure

- Introduce the no poverty creative project by citing Mahatma Gandhi: 'Earth provides enough to satisfy every man's need but not every man's greed.'
- Explain how important the issue of inequality on Earth has become and how we too should take part in bringing hope to people in need.
- Illustrate the problem by using the photographs from National Geographic (see Preparation).
- Use a map of the world to explain where living in poverty takes place.
- Teach the vocabulary: wealth, poverty, rich, poor and names of the continents.
- Discuss what students have watched and reflect on Gandhi's quote.

- Concentrate on material and non-material needs. To reflect on the question of wealth and poverty, you can use the following questions:
  - o What does it mean to be rich?
  - o What does it mean to be poor?
  - o What do you need to feel rich enough?
  - o What do poor people lack?
  - o What are universal basic human needs for well-being?
  - o Do you think you live in a rich or poor country? Why?
  - o What can you buy to feel rich?
  - o What can't you buy to feel rich?
- Help your students to express their thoughts in English and write them down.
- Discuss with students how to illustrate abstract nouns – love, friendship, kindness, warmth, goodness and truth – in a symbolic way.
- Explain that they are going to create a three-part poster (1. Material needs; 2. Non-material needs; 3. Basic universal human needs for well-being around the world).
- Introduce the language of co-operation and sharing.
- Divide the class into three groups to work on three parts. Give them old glossy magazines to cut out illustrations of material, non-material and basic human needs. They can also draw.
- As they browse magazines and cut out things, ask them to name the items, e.g. a car, a house, shoes, bread and so on.
- Display a big sheet of paper on the board and divide it into three parts. Let the children paste their drawings and cut-outs according to the parts. There will be a lot to discuss about where to stick the elements.
- Label the cut-outs and drawings.
- Summarise the classes and encourage students to write a short composition individually.

## Follow-up

- Display the posters in class or on a wall display in the school.

## Activity 2: CLIL elements in a playful use of maps

CLIL elements have become an important and inseparable part of the learning context. Language teachers don't just teach a language, they shape their students' minds and personalities so that they can act in a responsible way in the world. Maps are very rich sources to raise awareness of global citizenship and to teach geographical vocabulary to students of all ages and levels.

### Aims

- To nurture the feeling of responsibility
- To develop co-operative skills

### Language focus

- To learn and practise geographical vocabulary
- To develop the language of rules and instructions

### SDG focus

- SDG 1 No poverty – To develop sensitivity to other people's needs

### Creative focus

- Creating a board game triggers students' imagination.

Level B1  
Age 8–10 years  
Time 120 minutes

### Preparation

- Prepare black-and-white photocopies of a map of the world.
- Ask your students to collect black-and-white copies of a map of the world, a sheet of cardboard, glue, red and blue paint, brushes, water cups, tea packets, sand, pebbles, nutshells, matches, leaves, paper and pens.
- Find an example of the rules of a board game.

### Procedure

- Use a geographical and a political map and teach your students countries, nationalities, capitals and geographical vocabulary: mountains, river, sea, ocean and so forth.
- Encourage them to make mini-picture dictionaries.
- One by one, show the learners the materials: pebbles, used tea packets, matches, sand, leaves. Elicit ideas about what can be made out of each.
- Remind students of the no criticism rule. All ideas are acceptable at this stage.
- Explain that they will be creating a board game based on a map. The key idea of the game is helping the poor. They must decide on the design and the rules of the game.
- Introduce students to the language of instructions.
- Offer them some hints before they begin: paint the poorer developing countries of the world red, the seas and oceans blue; make a dice out of a tea packet and counters out of pebbles; make sailing boats out of nutshells, matches and leaves; mark tracks and routes with sand glued to paper.
- Divide them into groups. First they should discuss the key idea of the game, e.g. bringing humanitarian help to a poor country across lands and oceans, overcoming obstacles along the way and finding ideas about what players can do to alleviate poverty.
- Groups discuss what roles will be necessary in designing the game, and who should do what, e.g. two people work with painting a map and charting routes, two people make smaller objects for the game, another two write down the game rules, etc.
- Monitor the activity and help the students write down the rules in English.
- Groups present their games to the class, then they exchange their games and play the game they are given.

### Follow-up

- Share the games with other teachers.

### Activity 3: From mud huts to skyscrapers

'Every cloud has a silver lining' is a well-known saying. So what advantages can be found in extreme poverty where people are deprived of basic human rights and have no chance to retain their dignity? Discovering the 'silver lining' of living in poverty can be beneficial and educational. Students can also be shown how many wise and valuable people who transformed the world grew up in poverty and how much we can learn from them.

#### Aims

- To learn about the lives and work of such people as Mahatma Gandhi, St Francis of Assisi and José Mujica

#### Language focus

- To learn vocabulary of houses, rooms, furniture and prepositions of place
- To practise 'there is', 'there are' structures
- To write a description of place

#### SDG focus

- SDG 1 No poverty – To raise awareness of the creative power of poverty

#### Creative focus

- Illustrating the idiom helps students develop their metaphorical thinking.
- Making straw or stick houses triggers their imagination.
- Designing furniture and other facilities for the houses out of a flat sheet of paper stimulates their spatial imagination.
- Finding ideas about what toys can be made out of plastic bottles develops children's flexibility and originality of thinking.

Level B1  
Age 8–10 years  
Time 120 minutes

#### Preparation

- Prepare a short presentation on how housing structures have developed through the ages (from caves, mud huts, wooden, stone dwellings to modern buildings like skyscrapers).

- Prepare a short photo presentation on poor living conditions in today's world. Use the following sources :
  - o United Nations Development Programme – Poor housing and living conditions: [http://www.teamstoendpoverty.org/wq\\_pages/en/visages/logement\\_detail.php](http://www.teamstoendpoverty.org/wq_pages/en/visages/logement_detail.php)
  - o Living in favelas on the Issues in Brazil site: <http://tinyurl.com/mj9gv68>
- Videos about creative and cheap inventions in the world's poorest areas are available here:
  - o <https://www.youtube.com/watch?v=hPXjzsXJ1Y0>
  - o <https://www.youtube.com/watch?v=oSbZWNk84F4>
- Prepare short and simplified versions of the following texts to be useful for B1 students:
  - o the Mahatma Gandhi site: <http://mkgandhi.org/>
  - o St Francis of Assisi biography: <http://www.biography.com/people/st-francis-of-assisi-21152679>
  - o José Mujica: <http://www.bbc.com/news/magazine-20243493>

#### Procedure

- Discuss the saying 'Every cloud has a silver lining'. Encourage the class to give examples from their personal experience to illustrate the saying.
- Ask them to draw their ideas.
- Use your previously prepared presentation to show how hard necessity has pushed people to find better solutions through the ages.
- Familiarise students with living conditions in the poorest areas of the world. Use a photo presentation that you have made.
- Discuss and share your reflections on living in such conditions.
- Revise or teach the vocabulary of houses and furniture, 'there is'/'there are' structures and prepositions of place.
- Prompt children to construct in pairs simple straw and stick houses. Let them make modelling clay puppets and imagine what the puppets lack in their houses. Write down all the ideas on the board.

- Stimulate your students to design furniture and other facilities out of cardboard or paper and insert them in the houses.
- Each pair presents their house, practising describing places.
- Watch two videos that present creative and very cheap inventions that make poor peoples' lives bearable – litter light and eco cooler – devices made of plastic bottles (see Preparation).
- After watching the videos ask students to report what they have watched to a person who knows nothing about it. Be available as a monitor.
- Brainstorm ideas about what toys can be made from plastic bottles. They can be animals like penguins, rattling instruments (filled with peas or pebbles), vehicles or boats like catamarans.
- Make the toys.
- Introduce your students to the three characters: Mahatma Gandhi, St Francis of Assisi and José Mujica.
- Divide the class into three reading sections. Each group reads one text.
- Having read the texts, groups exchange their information with other groups.
- Ask students to choose their favourite figure and justify their choice.

### Follow-up

- Students write a description of a house they made in the lesson as their homework.

### Activity 4: From poetry to theatre in creative English teaching

Using poems helps foster a love of English. Poems are also very varied, so students usually find at least some of them inspirational and a nice change from a coursebook. They also offer plenty of opportunities to set up creative tasks involving personalisation (Smart, 2005).

#### Aims

- To foster a love of English through poetry
- To experience art – linking poetry and theatre to promote language learning
- To strengthen students' memory capacity

### Language focus

- To develop awareness of sound, rhythm and intonation
- To develop clarity of pronunciation

### SDG focus

- SDG 1 No poverty – To develop students' sense of empathy with the poor

### Creative focus

- Using associations and analogies to increase fluency, flexibility and originality of thinking
- Stimulating deductive thinking through interpretation of a poem
- Developing imagination through writing a screenplay and a story

Level B1  
Age 8–10 years  
Time 300 minutes

### Preparation

- Collect and provide pieces of old fabric, plastic bottles, wire, string, wooden sticks, paper, scissors, glue, crayons, cardboard.
- Find a picture of Picasso's The She Goat. See Picasso's website: <http://www.pablopicasso.org/she-goat.jsp>

### Procedure

- Present the materials to the students and ask them to find associations between the items and analogies between them. Aim at unusual associations and original analogies. No criticism at this stage – any ideas should be accepted.
- Present Picasso's sculpture The She Goat to the class and explain that it was made entirely of rubbish from a dump.
- Tell students they are going to work with a poem. Introduce the words: 'scare' and 'crow' separately and ask students to guess the content of the poem. Write their predictions on the board.
- Teach students some vocabulary, e.g. struggle, worn-out and patchy cloak, fierce gusts, make a plea, bearing in mind.
- Introduce and read the poem aloud.

### All Alone

In the vast fields of cut grain  
where you won't meet a friend,  
The scarecrow is standing  
all alone, without a home.  
Sick and cold,  
without a handkerchief to blow his nose,  
or a scarf to keep him warm.

The weather is dark and blustery.  
The wind blows strong  
with fierce gusts.  
You can lose yourself in the dust.

The scarecrow is struggling to stay upright,  
not to fall on the ground.  
The birds have flown away,  
nobody is there.

A worn-out hat and a patched up cloak  
do not protect him from the icy wind.  
The scarecrow has hope, though.  
But the poor man needs warm clothes,  
a cosy bed and a tissue to blow his nose.  
Some hut would serve him well,  
his troubles would go far away.  
The coming winter would not scare him any more,  
he would be safe,  
he would be warm.

Do you feel sympathy?  
No one would like to be  
in his miserable place.  
We should help him face  
the troubles he suffers –  
we should always help others.

(Sylvia Zabor-Żakowska, 2016)

- Discuss the main idea of the poem. Ask students to think of their personal experiences of helping others.
- Ask them to make a scarecrow from the available materials, then to take turns to role play the poem.
- Divide the class into groups of four and ask them to write a play script inspired by 'All Alone' by expanding the story, introducing the character of the goat and other characters, e.g. a dog, a farmer, a bird, etc. Monitor the activity.

- Ask the children to make paper puppets of characters. They can also create a scenography.
- Get groups to perform their play and video it.

### Follow-up

- Ask students to learn the poem by heart at home.
- As homework, ask them to write a letter on behalf of Scarecrow to a friend.
- Transform the poem into a story or write a contrasting story of a well-off and happy character.
- Publish these letters and stories in a school magazine if possible.

### Activity 5: Music as a universal means of communication

Music can be used to enhance the creative potential in our students. Sound can stimulate the other senses and the imagination. Music is a universal form of human communication which helps transcend cultural and religious differences.

#### Aims

- To raise students' awareness of conveying emotions, feelings and ideas through music
- To foster the feeling of togetherness among students and people in general through sharing music

#### Language focus

- To introduce vocabulary of musical instruments and materials
- To enhance speaking and writing skills

#### SDG focus

- SDG 1 No poverty – To build appreciation and understanding of the creative potential of people despite poverty

#### Creative focus

- Finding associations with sounds sharpens the sense of hearing and trains fluency, flexibility and originality of thinking.
- Trying to view the sounds helps cross-sensual perception and stimulates synaesthesia.

Level B1  
Age 8–10 years  
Time 135 minutes

## Preparation

- Look at these examples of musical instruments:
  - o guns turned into musical instruments: Artfido.com
  - o video material on Favio Chávez orchestra on YouTube: <http://tinyurl.com/lp3jdwu> and <https://youtu.be/yiYFculkBjU>
  - o Tadeusz Makowski's painting Children's Ensemble. Available on Pinterest site: <https://pl.pinterest.com/pin/535013630712542157/>

## Procedure

- Play a musical extract of Pedro Reyes's orchestra – don't let students see the video (the music starts at 6.20 minutes into the video).
- Ask them to give you associations with the sounds. Ask them also to think of what colours come to their mind. Write the given words on the board.
- Ask them to guess what the instruments are made of. Show short extracts of the material explaining that all the instruments in the orchestra are made of guns. Teach the 'to be made of' structure and discuss what other materials can be used to make instruments.
- Tell them in a few words about the Paraguay children's rubbish orchestra directed by Favio Chávez and show the YouTube video. Encourage them to read the English subtitles and make notes. Pause the video if needed.
- Talk about the instruments shown and what they are made of.
- Students discuss the following questions:
  - o What was Nicolas's most important lesson?
  - o How did playing music transform the players' lives?
  - o What values for their lives were mentioned?
  - o What can we learn from the musicians?
- Divide the class in pairs and ask them to make and play the classic memory game called Pelmanism:
  - o Each child draws two copies of an instrument on small cards (3 cm x 3 cm).
  - o The pack of all the cards is then shuffled and the cards placed face down on a table.
  - o Children take it in turns to turn over a card.
  - o They then replace it.

- o The idea is for children to remember where cards are so that they can pick up two matching cards.
- o The child with the most pairs of cards is the winner.
- Ask students to choose their favourite instrument and write acrostic poems. Here is an example:

s	axophone
a	nd
x	yllophone
o	h! oh!
p	lay for us all
h	ence
o	rdinary days
n	ever
e	nd senselessly

- Find the rhythms for the poems and rap them together.
- Introduce students to the painting Children's Ensemble by Tadeusz Makowski: <https://uk.pinterest.com/pin/459507968205265855/>
- Ask the students to guess what the content might be of the piece of folk music played by the children in the painting.

## Follow-up

- Encourage students to make DIY instruments at home. They improvise a piece of music in the classroom.
- Write a story from the words they associated with sounds at the beginning of the class.

## Bibliography

Borke, H (1971) Interpersonal perception of young children: egocentrism or empathy? *Developmental Psychology* 2: 263–269.

Buckley, N, Siegel, L and Ness, S (1979) Egocentrism, empathy and altruistic behavior in young children. *Developmental Psychology* 3: 329–330.

de Bono, E (1985) *Six Thinking Hats: An Essential Approach to Business Management*. UK: Little, Brown and Company.

Guilford, JP (1967) Creativity Test: Guilford's alternative uses task. Available online <http://www.indiana.edu/~bobweb/Handout/d1.uses.htm>  
Iannotti, R (1975) The nature and measurement of empathy in children. *The Counseling Psychologist* 2: 21–24.

Kapuściński, R (2001) *The Shadow of the Sun*. Canada: Knopf.

Kapuściński, R (2004) *Spotkanie z Innym jako wyzwanie XXI wieku* ('Meeting the other as a challenge of the XXI century'). Kraków: Universitas.

Kapuściński, R (2008) *The Other*. Verso.

Korczak J (1998) *Jak kochać dziecko* ('How to love a child'). Warszawa: Wydawnictwo Jacek Santorski.

Maley, A and Peachey, N (eds) (2015) *Creativity in the English language classroom*. London: British Council.

Marcus, R, Telleen, S and Roke, E (1979) Relation between cooperation and empathy in young children. *Developmental Psychology* 3: 346–347.

Nęcka, E (1992) *Creativity training: A guidebook for psychologists, educators, and teachers*. Kraków: TAIWPN Universitas.

Nęcka, E (2005) *Psychologia twórczości* ('The psychology of creativity'). Gdańsk: Gdańskie Wydawnictwo Psychologiczne.  
Smart, C (2005) <https://www.teachingenglish.org.uk/article/using-poems-develop-productive-skills>

Zabor-Żakowska, S (2016) *Poetry and Art for Creativity – Inspirations*. European Language Label. Poland: Rzeżucha Studio.



# 3

## Sustainable Development Goal 2: End hunger, achieve food security and improved nutrition and promote sustainable agriculture

Linda Ruas

### Introduction

Half the world is malnourished, the other half obese. The fact that access to nutrition is so unfairly distributed reflects, of course, the unjust global division of wealth and control. Everyone eats. And everyone has the power to fight for a fairer distribution of food, whether locally, by adopting a vegan diet or growing organic food; regionally, by petitioning supermarkets to reduce their waste; or globally, by writing to world leaders about food security, seed activism, food speculation or the control of huge multinational companies. We can involve learners in this actively both in class and outside, developing their grammar, vocabulary and skills with actions that can create change.

SDG 2 aims to end hunger and all forms of malnutrition and ensure sustainable food production systems by 2030; and to maintain the genetic diversity of seeds by 2020. If we involve students, they can put pressure on representatives and governments to work towards achieving these goals, for example with trade agreements and commodity markets.

Stories can play a powerful role in understanding the background to the current global food crisis. How does a coffee plant in Brazil become a cup of coffee in Belgium? Personal stories affect people, for example peasant farmers forced to leave their land and livelihood for more palm oil plantations. How far can we raise awareness of these important issues as learners simultaneously battle to master the English tense system?

There are innumerable questions to debate: for example, why large multinationals are using cheap land in the Global South for food where local people have lost their homes and livelihoods because they never had formalised rights to the land. How far are the ten most powerful food and beverage companies able to control the diets of most people and the use of most farmland? Does it matter if farmers use hormones and antibiotics or control their own supplies of seeds?

We can turn the classroom into a place where learners stop to think about their food, learn about issues outside mainstream media and develop their productive skills by speaking and writing about meaningful issues to work towards a fairer, healthier, more sustainable world.

Food is a global issue. However, it is also intensely personal. Food can be very emotional, deeply entwined with culture, religion and personal or family preferences. We therefore need to be very sensitive, not impose our views. We need to give learners time and space to research, discuss and think. We need to help learners to see the bigger picture of how one person's, or one country's, food affects far larger environmental and social issues.

We can guide students with the activities below to make informed choices. Everyone can relate to the topic of food, but not all activities about sustainability need to be serious. I recommend the activities are followed in order, but you do not, of course, need to do them all. The activities contain several complex ideas, but they are interspersed with lighter tasks to help the ideas sink in and hopefully engage students with the issues.

### Activity 1: Problems with food?

#### Aims

- To get students thinking about potential sustainability issues with common food

#### Language focus

- Yes/no questions, persuasion

#### SDG focus

- SDG 2 – Raising awareness of issues with foodstuffs

## Creative focus

- Developing guessing and matching through discussing foods

Level B1+  
Age 14+  
Time 60 minutes

## Preparation

- Cut up Worksheet 1 so that you have one picture for each student.
- Cut up Worksheet 2 so that you have one phrase for each student.
- Make copies of Worksheet 3 so that each student can have a copy.

## Procedure

- Hand out the pictures first. Ask each student to attach their picture to themselves without looking at it – with a sticker to the forehead or a pin or sticker to the back.
- Tell students they have five minutes to find out what food their picture is by showing it to others and asking yes/no questions, e.g. 'Is it green?' 'Do you think I eat it often?'
- When they've all found their food, students write all ten food names on the board:

chocolate	tea and coffee	(imported) avocados
meat	fish	nuts
palm oil	individually packaged biscuits	

- In groups, students discuss environmental or social problems that might be caused by people eating these foods.
- Hand out the cut-up Worksheet 2 and give one phrase to each student. Students now each have one picture of food and one phrase. Tell them they have to stand up and move around to find someone with a food that matches their 'problem phrase'.
- Hand out cut-up Worksheet 3. Students, in groups, read and match these to the foods in the list on the board.

- Elicit/practise persuasive language:
  - o Why don't you + inf?
  - o You could try ...
  - o It might be a good idea to ...
- Practise with some examples trying to persuade someone to change their eating habits, e.g. 'Why don't you eat less meat ...?'; 'You could try eating a different type of nut ...'
- Students stand in two lines, each facing a partner who they have to try to persuade to eat more sustainably. After three minutes, clap, stop them talking, move the student at the top of one line to the bottom and all other students along to a new partner. You can repeat this several times, and learners should get better at persuading their partners.
- Share what they've learned and find out who was successful in persuading others.

Materials – Worksheet 1

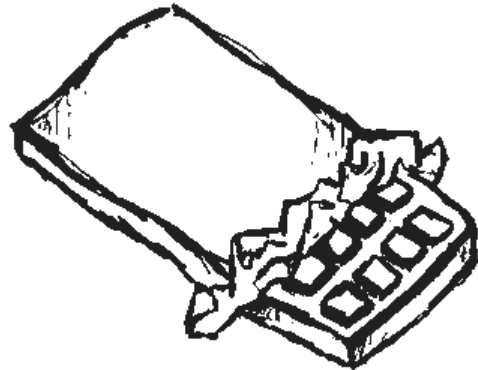
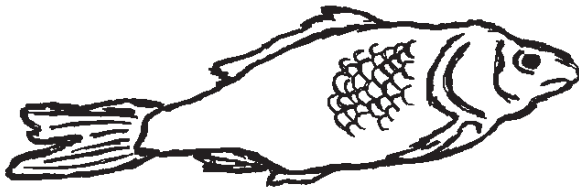
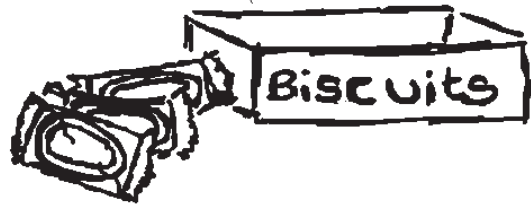

Visuals by Luciana Ruas

## Worksheet 2

Child labour/slavery

Food miles

Overfishing

Loss of biodiversity

Fairtrade

Land clearing / hormones / antibiotics

Too much water in processing

Too much packaging

## Worksheet 3

- a) It's often big, international companies that get the profit from tea and coffee, and the people who do all the hard work growing and picking get hardly anything. However, when tea or coffee producers become 'Fairtrade', this usually increases standards of living and reduces risk and vulnerability for farmers and workers. Fairtrade ensures the farmers get a minimum price for their produce, and this provides a safety net, which can mean they are not affected so much by sudden changes in prices on the market. Why not check that the coffee and tea you buy has a Fairtrade symbol on it?
- b) The distance the food has to travel from the farm to where it's finally sold and eaten is called 'food miles'. The energy used to transport food has a huge impact on the environment, because of all the carbon emissions released in fuel. It would save food miles if people bought and ate as much local food as they can, and restricted their diets more to seasonal food rather than taking for granted the huge choice of all possible fruits and vegetables all year round that Europeans have in supermarkets.
- c) There are several sustainability problems with eating many kinds of meat. One big problem with beef is the amount of land used: large companies from rich countries often buy cheap land in poor countries, cut down all the trees, clear all the vegetation and make the local people homeless. Cattle need a lot of food too (which people could eat instead), and processing meat uses a lot of water. Also, hormones and antibiotics are often used, which filter down into the meat and the water supply. Other problems with meat include maltreatment of animals, e.g. factory-farmed chicken. You could become vegetarian or vegan, reduce the amount of meat you eat or make sure you only eat organic meat from sustainable farms.
- d) When certain types of fish become very popular, commercial fishing catches so many of them that they start to die out. This is called 'overfishing' – more are caught and killed than are born. About 80 per cent of the world's supply of fish has already disappeared, and some scientists say that if fishing continues as it is now, many fish will have disappeared completely in 25 years. You could stop eating fish altogether. Or you could check which fish are on the 'seafood red list', and only eat those that are more sustainable.
- e) Plastic, paper and cardboard protect food, keeping it safe and clean. However, all this packaging produces a huge amount of waste and a lot of carbon emissions are created in the production of the plastic, paper and cardboard. There are also problems with toxic waste from producing plastic, and the fact that some plastics cannot be recycled. Possible solutions to this are getting people to eat fresh, local, seasonal produce, buying food from local farms and growing as much as they can of their own food.
- f) Several companies, especially in West Africa, use cocoa beans picked by children, sometimes under conditions of slavery. Many children are promised work and taken away from their parents. It is often extremely difficult to track exactly where the beans come from in the depots where the cocoa beans are bought, as they are transported from small villages to larger towns. There are several campaigns to investigate and stop slavery and child labour. You could check which companies can guarantee no child labour was used.
- g) Most of the commercially grown almonds in the world are grown in California and they need a lot of water. They have become very popular for their health value, but each almond takes one gallon of water to produce, and this is contributing to the drought and low water levels in the area. The processing of walnuts also uses a huge amount of water. You could switch to other nuts that use less water, e.g. pistachios or peanuts.

h) Many commonly used products contain palm oil, e.g. shampoo, ice cream, margarine and lipstick. Global production of palm oil has doubled over the last decade. New plantations are being developed and existing ones are being expanded in Indonesia, Malaysia and other Asian countries, as well as in Africa and Latin America. The problem is that, in order to create plantations, natural forest has to be cut down. This destroys the local plant and animal life, and many animals and plants are now becoming extinct, e.g. the orang-utan. These new plantations can also cause soil erosion and air, soil and water pollution. You could check the contents of all food and beauty products you buy and try to avoid everything with palm oil.

### Activity 2: The story of ...

#### Aim

- Students to understand and share processes of food production

#### Language focus

- Language for describing processes

#### SDG focus

- SDG 2 – To increase the productivity and income of small-scale farmers

#### Creative focus

- Creating visuals to show the food story

Level B1+  
Age 16+  
Time 60 minutes

#### Preparation

- You will need some poster paper and pens.

#### Procedure

- Show the students some tea, sugar, chocolate, coffee beans and cotton material.
- Ask them to discuss, in pairs, where they came from and what ‘the story of’ each product is.
- Get students into small groups and give them a large sheet of paper. Alternatively, if they have access to computers, they could work on a computer with some form of infographic or presentation software. Ask them to try to create a graphic showing the production process of one of the products.
- If they have internet access, allow them to do some research to find out more about the process.

- Feed in any language students need to describe the process.
- Once the visuals are complete, get the students to practise in pairs telling each other about the process they illustrated.
- Finally, students, in groups, discuss each food story to see if any stages include possible environmental or social problems. If so, how could they improve the process?

### Activity 3: Action newspaper

#### Aim

- For students to research food issues and summarise in a newspaper front page

#### Language focus

- To develop research and summary writing skills

#### SDG focus

- SDG 2 – To raise awareness of food issues relating to hunger, malnutrition, food commodity markets

#### Creative focus

- To create a newspaper front page with eye-catching headlines

Level B1+  
Age 16+  
Time 60 minutes

#### Preparation

- You will need large sheets of paper for newspapers.
- You will also need some free articles from Easier English New Internationalist wiki: <https://eewiki.newint.org>. If students have access to the internet, they can research the material online. If not, you can print out the five articles and activist campaigns before the lesson and stick them to the walls around the classroom.

#### Procedure

- Dictate the following topics as phrases:
  - o food speculation
  - o food for people not cars
  - o food waste
  - o junk food in schools
  - o global hunger.

- Students write them down individually, then in groups check spelling, decide on the meaning of each phrase and rank the phrases for importance in today's world.
- Call students to write the correct versions on the board and discuss what each phrase means.
- If you have a computer with internet, show the Easier English wiki: <https://eewiki.newint.org>. You could elicit the purpose of the wiki, then show how the 'Search' (top right) works.
- Each pair of students chooses two of the five phrases, and searches for an article. They read the article and decide how to summarise it.
- Write the names of international, national or local activist organisations on the board, e.g. Avaaz, Greenpeace, Change.org and 38 Degrees, and tell students in small groups to discuss:
  - o what they know about the organisations
  - o the food issues they expect them to raise.
- In pairs, students find three interesting activist campaigns related to food from the organisations.
- Get the pairs to discuss their research with another pair and decide on issues they feel strongly about and would like to get involved with.
- Ask them to decide what they can do about the issue, e.g. petitions, posters, protests, research and what the most important points are.
- Give each group a large piece of paper. Ask them to create a newspaper front page by writing headlines and summaries of the issues. They can also add drawings.
- Stick the newspaper front pages to the classroom walls or board. Students pretend they are editors and decide:
  - o which front page is best
  - o if there are any language errors to correct.

#### Activity 4: PMI and tweets

##### Aim

- To develop critical-thinking skills using Edward de Bono's PMI (Plus – Minus – Interesting) debate

##### Language focus

- Debating and summarising skills

#### SDG focus

- SDG 2 – GM crops and maintaining genetic diversity

#### Creative focus

- PMI debates and tweeting

Level B1+  
Age 16+  
Time 30 minutes

#### Preparation

- Make copies of Worksheet 1 PMI for each student.
- Look at this entry on Wikipedia explaining what GM crops are and make sure you can explain this simply to your students: [https://en.wikipedia.org/wiki/Genetically\\_modified\\_crops](https://en.wikipedia.org/wiki/Genetically_modified_crops)

#### Procedure

- Write on the board: 'It's a good idea to have GM crops.'
- Explain what GM crops are.
- Tell students, in pairs, to briefly tell each other what they think.
- Divide students into three groups to prepare as many points (at least four) as possible in ten minutes:
  - o Group 1 should think of positive plus points
  - o Group 2 should think of negative minus points
  - o Group 3 should think of interesting points.
- Students now hand out the relevant part of Worksheet 1 to give students more ideas.
- Make sure all students in all groups know their group's points, as they will soon have to work on their own.
- Regroup the students so that there is at least one from each of the P, M and I groups in each new group. They now have ten minutes to argue, using the points they have prepared.
- Now tell the class that the right-hand wall of the room represents agree totally, the left-hand wall represents disagree totally, and they can stand at any place between the two.
- Ask everyone to stand up and move to a place that represents their views.
- Ask them to sit down with another two or three who broadly agree with them and write a few tweets (maximum 140 characters) to summarise their arguments.

## Materials – Worksheet 1 PMI argument

'It's a good idea to have GM crops.'

[https://eewiki.newint.org/index.php/Is\\_there\\_a\\_place\\_for\\_genetically\\_modified\\_\(GM\)\\_crops\\_in\\_a\\_sustainable\\_future%3F](https://eewiki.newint.org/index.php/Is_there_a_place_for_genetically_modified_(GM)_crops_in_a_sustainable_future%3F)

### P (Plus):

- We need GM crops to feed the ever-growing world population.
- GM crops can reduce the use of pesticides.
- GM crops can make crops resistant to disease and therefore more reliable.
- Scientists are working on developing crops that can survive without rainwater.

### M (Minus):

- Hunger is a political problem and comes from poverty, not from agriculture.
- GM crops don't produce more food – they often produce less.
- Pests often find ways of adapting to pesticides used in GM crops and farmers need to develop different pesticides.
- Sometimes, farmers are forced to use GM seeds and the big companies stop selling non-GM seeds – bad for genetic diversity of seeds.

### I (Interesting):

- Millions of farmers in 29 countries already use GM crops on 160 million hectares of agricultural land (but this is only 3 per cent of farmland and 2.8 per cent of farmers).
- GM seed companies often have too much control over the seeds, the farms and the farmers.
- GM is only used so far for a few crops, e.g. soy, maize, canola and cotton.

## Activity 5: Challenge!

### Aim

- For students to compete and judge which food is more sustainable

### Language focus

- Language of description

## SDG focus

- SDG 2 – Ending hunger / ensuring sustainable food systems and habits

## Creative focus

- To think creatively about sustainable food and create a menu or change the way they eat

Level B1+

Age 16+

Time 10 minutes then 30 minutes a week later

## Preparation

- None

## Procedure

- Check that students know how to judge how sustainable food is by discussing and comparing a few examples, e.g. local, seasonal vegetables vs. imported, processed, packaged meat.
- You could also get them to do some research online to find out about sustainable food sources.
- Ask the class to choose one of these topics for a class competition:
  - o The most sustainable food diary – Every learner prepares a food diary, with photos, drawings and videos of all the food they've eaten for a whole week. The most sustainable week's food will win.
  - o The most sustainable café menu – Every student or group prepares a menu for a 'sustainable café', with pictures, photos and videos. The most sustainable menu will win.
  - o The best plan to end hunger and malnutrition in the world – Students produce plans to end hunger.
- Check all students understand:
  - o the resources to be used
  - o the time limit
  - o how the challenge will be judged.
- Ask another teacher to judge the competition entries, or get all learners to vote. Decide on another challenge for the following week!

## Activity 6: Pie charts

### Aim

- For learners to discuss and compare different diets around the world

### Language focus

- Language of comparison

### SDG focus

- SDG 2 – Looking at world diets and hunger and malnutrition around the world

### Creative focus

- Engaging with visual information in pie charts and graphs

Level B1+  
Age 16+  
Tim 30 minutes

### Preparation

- Prepare copies of Worksheets 1 and 2 from the Materials section.

### Procedure

- Show students Worksheet 1. They each draw a rough pie chart of the percentages of meat, dairy products and grain they think they eat, and compare with others by showing, asking and describing.
- Ask students to decide which students' diets are a) the most nutritious and b) the most sustainable, i.e. best for the planet.
- They then discuss these questions in small groups:
  - o How do you think these percentages vary around the world, e.g. what do you think the pie chart is like for: Spain, Somalia, India, Hong Kong?
  - o What do you think the section 'other' is made up of? Is it the same for each country?
  - o How do you think these percentages have changed in the last 50 years?
  - o How could food be shared more equally?
- Hand out Worksheet 2 and ask students, still in small groups, to compare them and discuss the reasons for the differences.
- You can elicit, feed in and practise new and varied ways of comparing, e.g. 'far exceeds', 'not nearly as much as', 'quite a lot', 'loads more than', 'almost as much as', 'roughly the same amount'.

- Show students this interactive link: <http://www.nationalgeographic.com/what-the-world-eats/>. If they have internet access they can research this alone or in small groups.
- Click on 'daily diet' at the top to investigate and compare different countries. Pairs of students choose two countries and compare their diets and discuss the reasons why, and any ideas they have for improving the diets.
- Click on 'meat consumption' to compare how much meat is eaten around the world. Students can choose two different countries and compare their meat-eating habits and discuss how this affects the environment, then present to the class.
- Elicit the main trends students have found. Ask students how these relate to hunger and sustainability, e.g. what would happen if all countries followed the example of China with meat-eating? What are the trends in the students' countries, and how are they helping or harming the planet? What ideas do they have for ending world hunger?
- Ask them to write a short summary of what they have learned.

### Materials – Worksheet 1

## World: Calories per person from different foodstuffs

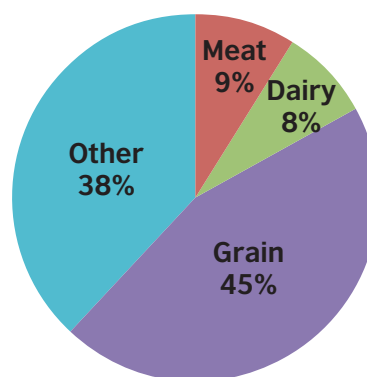



## Worksheet 2

The calorie intake from grain, dairy, meat and other in Spain, Somalia, Hong Kong and India.

### Spain

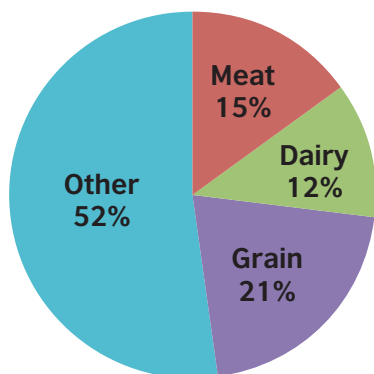

### Somalia

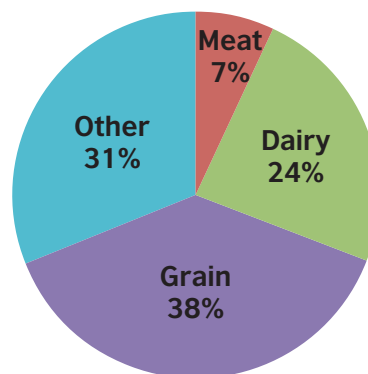

### Hong Kong

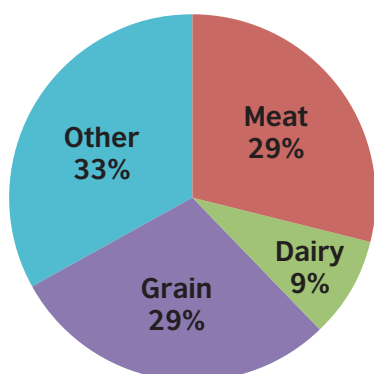

### India

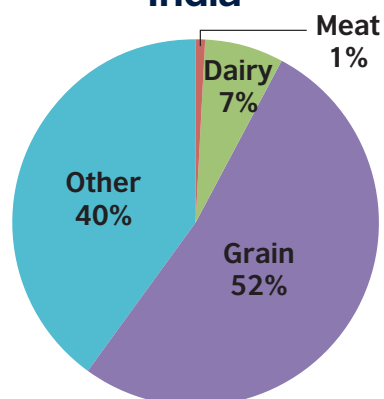

## Activity 7: Protest banners

### Aim

- For develop students' confidence and pronunciation in meaningful contexts

### Language focus

- To develop confidence and clarity with pronunciation

### SDG focus

- SDG 2 – To active involvement in food issues, e.g. food security and hunger

### Creative focus

- Creating protest banners and chants

Level B1+  
Age 16+  
Tim 30 minutes

### Preparation

- You will need some poster or flipchart paper cut into strips for banners

### Procedure

- In small groups, students decide on some really important things they want to say about environmental or social problems connected with food.
- You could introduce the idea of protests by showing pictures or talking about students' experiences of protests and banners.
- Ask each group to make two or more protest banners, each with a phrase they could chant while marching at a protest.
- You can give some examples, e.g. 'Stop wasting food – think before you throw anything away!'; 'Don't let cars eat all the food we need!'; 'No gambling on food!'
- Get learners to practise pronunciation of their phrases in groups. They can:
  - o add utterance stress
  - o practise the rhythm
  - o practise any difficult individual sounds or consonant clusters.
- After practising in groups, each group can chant their phrases to the class and get everyone chanting them together.

## Activity 8: DIY Grammar

### Aim

- For students to focus on the details of grammar and spelling in a text about eating less meat

### Language focus

- Contextualised accuracy

### SDG focus

- SDG 2 – Meat production and sustainability

### Creative focus

- Students dictating; learner-centred accuracy work

Level B1+  
Age 16+  
Tim 45 minutes

### Preparation

Print a copy of this text about eating meat for each student: [https://eewiki.newint.org/index.php/Stop\\_eating\\_meat!](https://eewiki.newint.org/index.php/Stop_eating_meat!)

### Procedure

- Hand out the text with the title removed. Ask students to read and decide in pairs on a title.
- Get the class to vote for the best title.
- Divide the class into groups of three: A, B and C. They then fold their text so that they can each see only one paragraph of the text: Student A – paragraph 1, Student B – paragraph 2 and Student C – paragraph 3.
- Each, in turn, dictates their paragraph to the others. When all three have finished, they can check their accuracy by unfolding their own text.
- Give one of the remaining paragraphs to each group. Each group of three now creates a gap-fill exercise by removing all verbs or all 'little words' (articles, prepositions, linkers) and writing the missing words in a list by the side.
- Groups swap their exercise with another group and do the gap-fill together, then check from their own text.

## **Additional resources**

New Internationalist Easier English Wiki

- This site has simplified articles, lessons and discussion topics: [https://eewiki.newint.org/index.php/Main\\_Page](https://eewiki.newint.org/index.php/Main_Page)

Film English

- This is a ready-made lesson about factory farming: <http://film-english.com/2013/10/14/the-scarecrow/>

IATEFL Global Issues Special Interest Group

- Food Issues month resources: <http://gisig.iatefl.org/tag/food-issues-resources>

ELT- Resourceful

- This is a ready-made lesson about fast food: <https://elt-resourceful.com/?s=chicken>

ELT Sustainable

- This is a ready-made lesson about 'Taking action': <https://eltsustainable.com/2012/07/30/take-action/>



# 4

## Sustainable Development Goal 3: Ensure healthy lives and promote well-being for all at all ages

Carmen Flores

Sustainable Development Goal 3 focuses on ensuring healthy lives and promoting well-being for everyone of all ages. There are three main themes for Goal 3. Theme one focuses on child health; the second theme focuses on maternal health and the third on HIV/AIDS, malaria and other diseases. Goal 3 comprises thirteen targets in order to achieve health and well-being. One of these targets is: by 2030, to reduce by one third premature mortality from non-communicable diseases through prevention and treatment and promote mental health and well-being. This target is the foundation for this chapter.

The main non-communicable diseases (NCDs) are: cardiovascular disease – heart attack and strokes – cancer, respiratory diseases such as chronic obstructive pulmonary disease, asthma and diabetes. There are risk factors and behaviours that take root in children and adolescents and then lead to adult NCDs. These include smoking, alcohol consumption, weight gain and obesity, and lack of exercise.

Another important component of Goal 3 is promoting mental health that can be negatively affected by being overweight and obese and can manifest itself in smoking or drinking among children and adolescents.

One of the ways that we can have a positive influence as teachers is prevention of the risk factors, since childhood and adolescence is a crucial time. Prevention can be achieved through having the knowledge and tools to make correct decisions.

The overall aim of this chapter is threefold. First is to empower students with the tools so that they are able to identify and choose healthy eating habits. Second is to create awareness of the need for daily exercise. Third is to address the topic of body image and raise consciousness about self-acceptance in students.

Through the activities in this chapter, students will become acquainted with vocabulary related to food groups, activity, health and adjectives to describe oneself. They will also enhance reading and speaking skills and promote use of technology and group work as part of students' autonomy.

### Activity 1: Making the right food choices

#### Aims

- The goal of the activity is for the students to get to know the different food groups, understand the 'Healthy Eating Plate' and to make the right choices.
- This activity also promotes students' autonomy and the use of technology.

#### Language focus

- Introduction and development of vocabulary from the names of the different food groups, the content of each and the vocabulary of the Healthy Eating Plate

#### SDG focus

- SDG 3 – Prevention of NCDs through healthy eating choices.

#### Creative focus

- Students are able to express their creativity by presenting the 'Healthy Eating Plate' of their choice.

Level A1–B2

Age 7–18

Time 4–6 hours

#### Preparation

- Students will need to have access to the internet to research healthy food groups.

#### Procedure

- Introduce the topic of healthy eating by writing on the board the different food groups (Fruits, Vegetables, Grains, Protein foods, Dairy, Oils).
- Ask students if they can name one food item for each category. Students can then come up to the board and write it under the right category. If students are unable to name a food, you can write a list on the board and have them match the foods to the groups.

- Now put the students into groups and get each group to research one of the food groups. Tell them to try to find out which foods are healthiest.
- Once they have done their research, ask them to create a presentation about their food group to share what they have learned.

### Follow-up

- At the end of the presentations, you can review the components of the 'Healthy Eating Plate' by drawing a circle on the board and asking students to give you directions for completing it.

### Additional resources

Here are some healthy eating infographics you can share with students:

- The Healthy Eating Plate: <http://tinyurl.com/zdxhew9>
- Healthy Swaps: <http://tinyurl.com/zf64t7o>
- Balanced Diet: <http://tinyurl.com/z2u69as>
- Clean up your Diet in 5 Weeks: <http://tinyurl.com/he7t4lb>

## Activity 2: Traffic Light

### Aim

- Introduce students to as many different foods as possible and place them into three categories according to how healthy they are for our bodies

### Language focus

- This activity introduces and reviews vocabulary related to food.

### SDG focus

- SDG 3 – Promoting healthy eating habits

### Creative focus

- Promoting creativity by having the students arrange the food into healthy and not-so-healthy choices

Level A1–B2  
Age 7–18  
Time 60 minutes

### Preparation

- You will need to make copies of the following documents from the Materials section for each student:
  - o Worksheet 1: Healthy eating quiz
  - o Worksheet 2: Traffic light worksheet
  - o Worksheet 3: Food list

### Procedure

- Introduce the topic by asking your students what types of snacks they eat. Write them on the board.
- Write two columns headed 'Healthy' and 'Unhealthy' and ask students to classify the words on the board.
- Now, hand out students a 'Healthy eating quiz' and give them five to ten minutes to answer, making sure they understand the questions.
- When they have finished, ask them to check their score.
- The next part of the class can be done in pairs or individually.
- Hand out the Food list worksheet and make sure students know the vocabulary. They can look up unfamiliar words in a dictionary.
- Hand out the Traffic light worksheet and have them complete it by putting the words from the food list into the correct columns.

### Follow-up

- Ask them to put the Traffic light worksheet on their refrigerator door for a week and check if they have been following it. They can report back to the class about it.

## Materials – Worksheet 1: Healthy eating quiz

**Circle the best answer for each of the questions.**

1. In one day, how many servings of fruit do you eat?
  - a) None
  - b) One
  - c) Two or more
2. What do you usually eat for breakfast?
  - a) I don't eat breakfast
  - b) Something quick like cereal or doughnut
  - c) A hot breakfast with eggs, milk or oatmeal
3. What do you usually eat for supper or dinner?
  - a) I don't eat dinner
  - b) Something quick like cereal or bread, pizza or burgers
  - c) Usually meat, fish or chicken, salad or pasta
4. When do you usually have your last meal of the day?
  - a) 30 minutes or less before bedtime
  - b) One hour before bedtime
  - c) Two or more hours before bedtime
5. How many snacks (potato chips, cookies, candy, chocolate) do you eat in a day?
  - a) Four or more a day
  - b) Two to three a day
  - c) One or none a day
6. How many vegetables or salad do you eat in a day?
  - a) None
  - b) One to three
  - c) Four or more
7. How many times a week do you eat in a fast-food restaurant (pizza, burgers, tacos)?
  - a) Three or more
  - b) One to two
  - c) None
8. What do you usually drink with your food?
  - a) Soda, juice or Kool-Aid
  - b) Natural fruit drinks with sugar (lemonade or tea)
  - c) Water
9. How many sugary drinks do you drink in a day (soda, juice)?
  - a) Three or more a day
  - b) One or two a day
  - c) None

### **Now count your points!**

You have 1 point for each letter a), 2 points for each letter b), and 3 points for letter c).

Results:

9–15 points: Your eating habits are unhealthy.

- You need to start eating more fruits and vegetables and drink water with your meals. Also, change your snacks for fruits, yogurt and nuts.

16– 21 points: Good! You are on your way to eating healthily.

- Keep up the good work and work on your water intake.

22–27 points: Your eating habits are healthy.

- Congratulations!

## Worksheet 2: Traffic light worksheet

<b>Green</b> They are healthy. You should eat	<b>Yellow</b> You should eat these in moderation	<b>Red</b> Try to avoid as much as possible

<b>Food list</b>		
Eggs Soft drinks Doughnuts Cake Soup Spaghetti Tea Cereal Chicken Hamburger Chicken wings Chocolate Beans Peas Green beans Squash Celery Avocado Cucumbers	Honey Hot cakes Cupcakes Pecans Almonds Whole milk 1% milk Bacon Turkey Butter Ice cream Apples Yogurt Gorditas Quesadillas Nachos Tortillas Flour tortillas Chips	Cookies Steak Fries Fish Salmon Carrots Tomatoes Potatoes Salad Lettuce Cheese Rice Wheat bread White bread Garlic Onion Popcorn Ham Candy



### Activity 3: Are you active or not?

#### Aim

- This activity aims to create awareness through the completion of a quiz of how active a student is, and to find five things they would change for better health.

#### Language focus

- Activity-related language

#### SDG focus

- SDG 3 – Prevention of and consciousness-raising about the importance of physical exercise

#### Creative focus

- To encourage students to think about how they can improve their own health

Level A2–C1  
Age 8–18  
Time 20 minutes

#### Preparation

- You will need copies of Worksheet 1: Are you active? for each student.

#### Procedure

- Start the activity by asking students if they practise any kind of physical activity and write them on the board.
- Hand out the quiz to each student.
- Check their understanding of the vocabulary.
- Give eight to ten minutes for students to read and answer each question.
- When time is up, students are to count their points and see how active they are.
- You can ask students randomly to share their answers.
- On the board, write the sentence: 'For better health I will ...'
- Now give students five minutes to write at least three things they are willing to change for better health.
- Randomly ask students what they are willing to do.

#### Follow-up

Tell students that for the next week they will try to do what they wrote down. You can make a chart for them to check whether they are fulfilling their targets.

### Materials – Worksheet 1: Are you active?

#### Circle the best answer for each of the questions.

1. How many times a week do you practise a physical activity outdoors like playing ball, riding a bike or skating?
  - a) 4 to 5 times a week
  - b) 2 to 3 times a week
  - c) Never
2. In a day, how much moderate exercise (when your heartbeat is fast) do you practise?
  - a) 60 minutes or more
  - b) 30–60 minutes
  - c) 0–30 minutes
3. How often do you walk, bike or skate to and from school?
  - a) Almost always
  - b) Sometimes
  - c) Never
4. In a day, how much time do you spend watching TV, playing videogames or in social sites?
  - a) 1–2 hours
  - b) 2–3 hours
  - c) More than 3 hours
5. How often do you do physical activities with your family, like going for a walk or swimming?
  - a) More than three times a week
  - b) 1–2 times a week
  - c) Never
6. Do you practise a sport like baseball, football or gymnastics at school or after school?
  - a) Yes
  - b) No

**Results:**

18–14 points: Your physical activity habits are healthy.

- Congratulations you are on the right track! Keep on exercising regularly.

13–9 points: Good! You are on your way to good health.

- Keep up the good work and less TV and videogames.

8–5 points: Your physical activity habits are unhealthy.

- You need to practise an activity or sport at least five times a week for 30 minutes.  
Walk more and less television and videogames.

### **Additional resources**

Youth Physical Activity Guidelines Toolkit

- This site has some useful tips and advice to help young people stay fit and active: <https://www.cdc.gov/healthyschools/physicalactivity/guidelines.htm>

### **Activity 4: I see myself ...**

This could be a potentially difficult activity to do with a group of teens, so make sure both you and they are comfortable together before trying it.

#### **Aim**

- To promote a healthy body image by focusing on the good things about one's body and feeling comfortable talking about them

#### **Language focus**

- Vocabulary development, especially adjectives that describe the body
- Developing speaking skills

#### **SDG focus**

- Goal 3, with a focus on promoting mental health through working on positive body-image issues

#### **Creative focus**

- This activity promotes empathy and creating a healthy body image by students making a collage of themselves.

Level A2–C1  
Age 7–14  
Time 45 minutes

#### **Preparation**

- Students need to bring to class at least two magazines with plenty of pictures to cut out.
- Scissors, glue, markers and sheets of A4 paper and tape

### **Procedure**

- Write on the board the words 'My body. I am unique' and ask the students if they know the meaning of the words.
- Tell them that they will be talking about the way they look, their appearance.
- Students work in groups of four. Give each student a large piece of blank paper.
- Ask the students to create a collage of him - or herself (any way they wish) in the middle of the paper. They can use pieces cut from the magazines to make the collage.
- Ask them to write on the right side five things they like about their body or looks, and on the left side one thing that they do not like.
- Monitor and help students with vocabulary as needed.
- Now, in their groups, ask students to show their collages to each other and explain why they like each part they wrote down (e.g. 'I like my hair because it is just like my mother's hair.')
- Give a couple of minutes to each student to share their collage with the rest of the class.

#### **Follow-up**

- After all the groups are finished, students come to either the board or a wall in the classroom and tape their collages for everyone to see and appreciate how everyone is different.

### **Additional resources**

WebMD – Body Image and Children

- This site provides further reading on this topic: <http://www.webmd.com/parenting/building-healthy-body-image-for-children>

## Activity 5: Beautiful

### Aim

- The aim of the activity is for students to develop a more inclusive understanding of body image.

### Language focus

- The focus is on vocabulary, listening and reading comprehension.

### SDG focus

- The focus is on SDG 3, to promote good mental health through positive body image.

### Creative focus

- Listening to music and drawing

Level A2–C1  
Age 11–18  
Time 35–45 minutes

### Preparation

For this lesson you will need:

- a recording of the song ‘Beautiful’ by Christina Aguilera. You can probably find this on: <https://www.youtube.com/> or <https://www.spotify.com>
- the lyrics of the song. You can find these on Google by typing in ‘lyrics “Beautiful” by Christina Aguilera’
- some big pieces of blank paper.

### Procedure

- Write the word ‘Beautiful’ on the board.
- Ask students if they can name something that is beautiful.
- Ask students if they have heard the song.
- Ask students to work in groups of three or four. Give each group the lyrics of the song. Students should underline words they do not know.
- Play the song and students can sing along or follow using the lyrics sheet.
- Give each group a big piece of blank paper and markers.
- Ask them to draw what the song reflects about body image.
- Each group comes to the front of the class and shares their view of the song.

### Follow-up

- Ask each group to write on the board the positive things they got from the song. What is the message of the song?

### Additional resources

Men’s Standards of Beauty Around the World

- This is the male version of the video above: <https://youtu.be/tneKwarw1Yk>

### Further resources

Sustainable Development Goal 3

- This site contains a more detailed description of the elements of SDG 3: <https://sustainabledevelopment.un.org/sdg3>

UNDP

- This site shows information about projects and activities that are taking place in order to try to achieve the goal: <http://www.undp.org/content/undp/en/home/sustainable-development-goals/goal-3-good-health-and-well-being.html>



# 5

## Sustainable Development Goal 4: Ensure inclusive and equitable quality education and promote lifelong learning opportunities for all

Daniel Xerri

### Introduction

Teaching students about the United Nations' (UN) 17 Sustainable Development Goals (SDGs) has been shown to enhance their academic skills, foster their mental and moral development, boost their motivation and improve their future employment prospects (British Council, 2015; Think Global and British Council, 2011). By learning about SDG 4, students become familiar with why we need to ensure inclusive and quality education for all and to promote lifelong learning. This seems essential in the light of the following disconcerting figures.

- Despite the fact that enrolment in primary education in developing countries has reached 91 per cent, around 57 million children remain out of school (UN, 2016).
- More than half these children live in sub-Saharan Africa, and it is estimated that 50 per cent of out-of-school children of primary school age live in conflict-affected areas (UN, 2016).
- Worldwide, 103 million young people lack basic literacy skills, and more than 60 per cent of them are women (UN, 2016).

SDG 4 comprises ten targets that constitute ways in which quality education can be made universally accessible by 2030. For example, aims state that 'all girls and boys complete free, equitable and quality primary and secondary education' and that 'all youth and a substantial proportion of ... both men and women, achieve literacy and numeracy' (UN, 2015: 17). An emphasis on inclusion and gender equality runs through these targets, aligning this goal with some of the targets of SDG 5, which is aimed at achieving gender equality and empowering all women and girls. One of the targets of SDG 4 urges countries to 'eliminate gender disparities in education and ensure equal access to all levels of education and vocational training for the vulnerable, including persons with disabilities, indigenous peoples and children in vulnerable situations', (UN, 2015: 17). Quality education is conceived of as an

inclusive and equitable force and this makes SDG 4 a means by which to achieve some of the targets of SDG 10 too, which is aimed at reducing inequality within and among countries.

In 'The World's Largest Lesson', an animated film that can be used to introduce students to the SDGs, much emphasis is placed on how young people's creativity can be tapped to solve some of the world's problems. This chapter focuses on how English language learning and teaching can harness creative activities as a means of targeting the fourth sustainable development goal.

In this chapter, creativity is conceived of as a democratic phenomenon that all teachers and students can access and which may involve the reconfiguration of already existing elements rather than merely the creation of something out of nothing (Xerri and Vassallo, 2016). Moreover, creativity is seen as something that 'is born of discipline and thrives in a context of constraints' (Maley, 2015: 6). The harnessing of creativity in the classroom is deemed fundamental, given the paradox of it being 'at the heart of learning but not at the heart of education' (Maley and Bolitho, 2015: 435). Through a series of activities that seek to mobilise students' creative thinking, the chapter describes how the English language classroom can serve as an incubator for an awareness of the need to ensure inclusive and equitable quality education, and to promote lifelong learning opportunities for all.

### Activities

The activities outlined below seek to tap into students' creativity in order to identify ways of achieving some of the SDG 4 targets. The activities are designed for intermediate to advanced (B1–C1) second language students in secondary schools in high-resource environments. Each activity aims to raise awareness about the importance of providing quality education to all boys and girls, and men and women in the developing world. The activities encourage students to contribute creatively to the attainment of SDG 4.

## Activity 1: Identifying original and effective solutions

This activity encourages students to identify original and effective solutions to some of the challenges to quality education highlighted in video case studies from different contexts.

### Aims

- To enable students to listen for detail
- To enable students to understand the challenges that prevent children in different contexts from receiving a quality education
- To discuss ways of overcoming the challenges mentioned in the videos and identify original and effective solutions to each challenge
- To enable students to present their solutions persuasively to their peers
- To enable students to evaluate the different solutions and select the winning ones.

### Language focus

- To developing students' listening and speaking skills

### SDG focus

- All ten targets forming SDG 4 were written to address the challenges to quality education around the world. This activity raises students' awareness of some of these challenges and enables them to formulate solutions that would help to achieve several of the targets.

### Creative focus

- Enabling students to identify original and effective solutions to some of the challenges to quality education

Level B1 and upwards  
Age 12–18 years of age  
Time 60 minutes

### Preparation

- Three video case studies produced by UNICEF and UNHCR serve as the basis for the activity. The first video ([goo.gl/hihw0R](http://goo.gl/hihw0R)) focuses on girls in Madagascar who do not complete their education because of early marriage, while the second video ([goo.gl/AY2MOH](http://goo.gl/AY2MOH)) is about a child forced to stop her schooling because of the conflict in Syria. The third video ([goo.gl/VXwZdT](http://goo.gl/VXwZdT)) presents some of the challenges that children in South Sudan face on a daily basis in their efforts to receive a quality education.

### Procedure

- Play the three videos. Ask students to note down all the challenges mentioned in each one. Pause after each video and replay if necessary. Students compare answers with a partner. Check answers with the whole class at the end.
- Ask students to form groups of four. Provide them with a brief definition of the criteria of originality and effectiveness. You can either use the following or devise your own in consultation with students:
  - o an idea needs to be unusual, novel and unique, as well as possessing value and usefulness (Runco and Jaeger, 2012).
- Ask each group to identify solutions to the challenges mentioned in the videos in line with these two criteria.
- Each group nominates a representative to present the group's solutions to the rest of the class.
- While listening to each presentation, students individually award points based on the criteria of originality and effectiveness.
- Ask students to pair up with a partner from a different group and discuss the respective points awarded.
- Together with the class, count the total number of points awarded to each solution and announce the winning solutions.

### Follow-up

- For homework, ask students to research some of the solutions that UNICEF and other international organisations have come up with in order to address challenges to quality education (see below for resources).
- Once these solutions are presented in class, students can analyse them using the same criteria of originality and effectiveness they used to evaluate their own proposed solutions.

### Additional resources

UNICEF's YouTube channel

- This provides a useful resource since it contains a number of video case studies from different contexts illustrating solutions to the challenges affecting children's quality education: <http://goo.gl/y4EBW5>

## Activity 2: Transforming texts, transforming problems

This activity enables students to use a multimodal approach in order to transform a reading text about the future of children affected by the crisis in Syria. Multimodality involves the skilful combination of different modes of communication so that a text is transformed into something with enhanced communicative potential (Xerri, 2016). This activity provides students with the means to transform a printed text into a multimodal one in order to communicate how problems affecting children's education need to be transformed into opportunities. The activity described below can take place after a number of pre-reading activities, where necessary.

### Aims

- To enable students to skim through the text, highlighting the parts referring to children's education
- To enable students to check the meaning of unfamiliar vocabulary by means of a dictionary
- To enable students to summarise the highlighted parts of the text using their notes
- To enable students to plan the content and organisation of a video presenting the information contained in their summaries
- To enable students to negotiate content and organisation through discussion
- To enable students to create a storyboard of a brief video clip presenting the summarised information

### Language focus

- To develop students' reading, writing and speaking skills

### SDG focus

- Two of the ten targets constituting SDG 4 underscore the importance of providing vulnerable children with access to quality education by providing a safe and non-violent learning environment. This activity develops students' understanding of the problems such children face on a daily basis and enables them to consider how the relevant targets might be achieved.

### Creative focus

- This activity enables students to engage in the necessary preparatory work for them to harness their digital literacy for the creative reconfiguration of information in a written text.

Level B2 and upwards  
Age 12–18 years of age  
Time 60 minutes

### Preparation

- The core text of this activity is a brief UNICEF (2014) report entitled No Lost Generation. This is the name of a strategy aiming to engage in sustainable measures to increase displaced children's learning and skills, providing them with a protective environment and broadening their opportunities.

### Procedure

- Ask students to read through the text quickly and highlight all the parts referring to education. Ask students to pair up and check that they have identified all the relevant parts.
- Ask them to read the highlighted parts and use a dictionary to check the meaning of any unfamiliar words.
- Then students work in pairs and make a note of the most important information in each highlighted part of the text. The notes should be in their own words.
- Ask them to write a 100-word summary of the highlighted parts of the text. They should do so using only their notes, without referring back to the original text.
- After completing their summary, students compare it with the original text to check that they have noted the ideas it contained accurately and in their own words.
- Ask them to form groups of five and read each other's summaries, thus ensuring, through repeated exposure, that they have all focused on the most important information about education in the original text.
- In groups, students discuss the content and organisation of a video they will make. Their video will present the information they summarised. By means of a storyboard they agree on choice of images, film, text, music and voice-over. Students can use either a printed or digital storyboard (e.g. [www.storyboardthat.com](http://www.storyboardthat.com)). Explain that the aim of the video is to highlight the problems and required resources identified in the original text, both of which should have featured in the students' summaries.

## Follow-up

- In a subsequent lesson encourage students to present their storyboard to the rest of the class, or else the video they have created in groups for homework. To produce their videos they can use applications such as Movie Maker and iMovie. Ideally, these videos should be published on the class's YouTube channel.

## Additional resources

Syria: No Lost Generation

- UNICEF has produced a set of teaching resources that you may use in subsequent lessons or for homework purposes. These resources are centred on a student magazine which explores how children's education is being affected by the conflict in Syria. There are also supplementary activities that engage students in an analysis of photos, videos and numerical figures: <https://teachunicef.org/unicef-act/syria-no-lost-generation>

## Activity 3: Mediating an effect

This activity enables students to condense the data presented in an infographic about girls' education into a poster consisting of visuals and a brief slogan. One of the disadvantages of some infographics is that they contain too much data. This activity encourages students to comb through the data and selectively focus on what is the most important message at the heart of an infographic.

### Aims

- To enable students to identify and describe the purpose or content of each part of an infographic
- To enable students to read the data in the infographic
- To enable students to discuss what they regard as the most significant piece of information in the infographic

## Language focus

- To develop students' reading, speaking and writing skills

## SDG focus

- Seven of the ten targets in SDG 4 refer to the importance of ensuring equal opportunities in education for girls (and women) as much as for boys (and men). This activity develops students' understanding of the challenges posed to girls' quality education around the world and enables them to think about how the relevant targets can be achieved through effective awareness-raising.

## Creative focus

- The activity facilitates the use of students' creativity in order to communicate a succinct and compelling message about the importance of nurturing girls' sustainable education. Through their negotiation and collaborative design of a poster, students show their ability to think about what is involved in producing an incisive, memorable message that has a lasting effect on its audience.

Level B1 and upwards  
Age 12–18 years of age  
Time 60 minutes

## Preparation

- The infographics used in this activity were produced by USAID: <http://goo.gl/oK32Mb>, Global Partnership for Education: <http://goo.gl/m0LqwY>, UN Women: <http://goo.gl/t5I4wg>, UNICEF: <http://goo.gl/oAiuYp> and Intel: <http://goo.gl/18pdgo>.

## Procedure

- Ask students to form groups of four and provide each group with a different infographic.
- In groups, students discuss the layout of the content and the possible purpose of each part, as well as how it corresponds to other parts. Ask one student from each group to relay this information to the rest of the class.
- Ask students to read the data in the infographic and individually determine what they consider to be the most important piece of information.
- Students share their views in groups of four and justify their choices. Encourage them to reach agreement about the most significant fact.
- In groups, students plan the visual aspect of a poster and write a brief slogan or message, which should be based on the most important fact they have identified.

## Follow-up

- For homework, each group produces a poster by using either software like MS Publisher or websites like [www.canva.com](http://www.canva.com) or [www.fotor.com](http://www.fotor.com).
- In a subsequent lesson, they present their poster to the rest of the class and it is evaluated in terms of the effect it is likely to have on an audience. Each poster is hung in the classroom and published online.



## Additional resources

If you would rather use fact sheets instead of infographics, there are a number of these on girls' education published by UNESCO: <http://goo.gl/PsF1XZ>, Circle of Sisterhood: <http://goo.gl/XJoqlw>, malala.org: <http://goo.gl/2KzTLq>, The World Bank: <http://goo.gl/JKhDsQ> and USAID: <http://goo.gl/ljz3hs>.

## Activity 4: Empathising for inclusion

This lesson offers activities that enable students to understand the difficulties experienced by children with disabilities and to empathise with them in their efforts to access a quality education. The latter is conducted through poetry writing, which has been shown to help galvanise students' empathy for vulnerable people (Xerri and Xerri Agius, 2015).

### Aims

- To enable students to describe photos of children with disabilities learning in different global contexts
- To enable students to understand how disability might affect children's education
- To enable students to identify the problems, causes, consequences and solutions associated with the education of children with disabilities
- To enable students to understand the poem's main ideas by watching the video and reading the transcript
- To enable students to draft a poem written from the point of view of the child with a disability

### Language focus

- To develop students' speaking, reading, listening and writing skills

### SDG focus

- Inclusion is an integral part of quality education as conceived of in SDG 4; two of its targets address the need to ensure that persons with disabilities have equal access to education and training. The activities forming part of this lesson enable students to gain an understanding of the difficulties that children with disabilities have to face in their efforts to receive a quality education.

### Creative focus

- These activities encourage students to use their imagination to develop a clearer understanding of the challenges experienced by children with disabilities. The act of poetry writing enables them to adopt the point of view of such children and thus increase empathy.

Level B2+  
Age 12–18 years of age  
Time 90 minutes

## Preparation

- Parts of this lesson are based on a Flickr album entitled 'Education and Disability': <https://www.flickr.com/photos/gpforeducation/sets/72157633448398454/with/22413001278/>, which was compiled by Global Partnership for Education, which also authored the text on the education of children with a disability that is used in this lesson: <http://www.globalpartnership.org/focus-areas/children-with-disabilities>. The last activity is based on the spoken word poem 'Every Time I Step Outside': <https://youtu.be/psa9IpuGPNc>

## Procedure

- Provide each student with a photo from the album 'Education and Disability'. In pairs, students describe their photos to each other. Ask them to identify what the photos have in common.
- Encourage students to discuss how disability might affect children's education. Elicit some ideas from them.
- Ask them to scan the overview section of the webpage 'Children with disabilities' and identify the number of people living with a disability in the world at present.
- Ask them to read the overview and look up the meaning of any unfamiliar vocabulary using a dictionary. If necessary, help with words like 'discrimination', 'marginalised', 'implications', 'stigma', 'constrained', 'transition', 'unconducive' and 'mainstreamed'.
- Using comprehension questions, ask them to identify the problems of children with disability experience with respect to education, as well as the causes and consequences of and suggested solutions to these problems.
- Encourage them to think about how they would personally cope with a disability as part of their daily school routine and to discuss this with their partner.
- Encourage them to predict what the video 'Every Time I Step Outside' will be about. Play the video and ask them to confirm whether their predictions were correct.

- In groups of four, they discuss and identify the main ideas the speaker is trying to communicate in the spoken-word poem. Play the video again and, finally, provide them with its transcript. Draw particular attention to the last four lines.
- Using the photo you provided them with at the beginning, ask them to imagine what the child in their photo would say if they had to write a poem entitled 'Every Time I Step Outside'. Ask them to write a draft of the poem, and provide feedback.

### Follow-up

- At home students revise and polish their poem and, if they wish, learn how to recite it or perform it as a spoken-word piece.
- Encourage them to either video record themselves performing the poem or else produce an audio recording of their performance which will overlay a video made up of a sequence of images related to the poem's content.

### Additional resources

Global Partnership for Education has produced a number of blogs about how children with disabilities in Eritrea (<http://goo.gl/uqZMQX>, Zanzibar <http://goo.gl/Ry36yY>) and Cambodia (<http://goo.gl/5j0dxv>) are being supported in their efforts to receive a quality education. If you are interested in exposing students to the perspective of a young person with disabilities, you might wish to show students a video called 'Disabled and living in the real world' (<http://goo.gl/afNk3u>). Robyn Lambird's YouTube channel (<http://goo.gl/1mvTA5>) is a good resource for spoken-word poems and other videos related to disability and young people. One of the best-known poets with a disability is Jim Ferris, some of whose poems are found online, e.g. 'Poems with Disabilities' (<http://goo.gl/jhmsDH>).

### Further resources

Video – The World's Largest Lesson – Part 1

- This video serves as a good introduction to the SDGs, with the first part providing information about the goals and the second part illustrating how creativity is being used to solve some of the problems targeted by these goals: <https://goo.gl/lbSDhF>; Part 2: <https://goo.gl/CYgGVF> –

Teach UNICEF – Sustainable Development Goals

- This website contains lesson plans, activities and videos that can act as an introduction to the SDGs: <https://goo.gl/Kvx6G4>

Practical Action – Global Goals

- A number of different materials designed to help students understand the SDGs are found on this website: <https://goo.gl/NGa2Pz>

British Council – Voices

- This magazine article describes how and why to teach the SDGs, as well as indicating some of the resources you could use to do so: <https://goo.gl/Y2ilCi>

Oxfam – Sustainable Development Goals

- This website is made up of a selection of teaching ideas on the themes of the SDGs, including education, skills and jobs: <https://goo.gl/b3tTwD> –

Send My Friend to School – Resources

- A large variety of resources are found on this website, all of them dealing with barriers to quality education: <https://goo.gl/Oj0Jsp>

World's Largest Lesson – Quality Education

- A number of resources are available on this website if you are interested in learning more about how to promote creative engagement with the Sustainable Development Goal of quality education for all: <https://goo.gl/YX76tA> –

Global Dimension – Quality Education

- This website contains a number of lesson plans and other resources designed around SDG 4: <https://goo.gl/Y673de>

British Council – SchoolsOnline

- If you are interested in establishing a partnership with another school as a means of enriching your students' understanding of cultural diversity and sustainability, this is a good website to access: <https://goo.gl/8Cccv4>

British Council – Quality Education for All Children

- Project templates are available to facilitate collaboration between schools and these are based around the SDGs, including one on SDG 4: <https://goo.gl/d3081Z>

## References

British Council (2015) World class: How global thinking can improve your school. London: British Council. Retrieved from <https://goo.gl/BF5k12>.

Maley, A (2015) 'Overview: Creativity – the what, the why and the how', in A Maley and N Peachey (eds) Creativity in the English language classroom. London: British Council: 6–13. Retrieved from <https://goo.gl/Uzki3y>.

Maley, A and Bolitho, R (2015) Creativity. *ELT Journal* 69(4): 434–436.

Runco, M A and Jaeger, GJ (2012) The standard definition of creativity. *Creativity Research Journal* 24(1): 92–96.

Think Global and British Council (2011, December) The global skills gap: Preparing young people for the new global economy. London: Think Global and British Council. Retrieved from <https://goo.gl/nlf8BH>.

UN (2015, October 21) Transforming our world: The 2030 agenda for sustainable development (Resolution adopted by the General Assembly on 25 September 2015). Retrieved from <https://goo.gl/mrgOcA>.

UN (2016) Goal 4: Ensure inclusive and quality education for all and promote lifelong learning. Retrieved from <https://goo.gl/fZ5kEZ>.

UNICEF (2014, January) No lost generation: Protecting the futures of children affected by the crisis in Syria. Retrieved from <https://goo.gl/3YVJTQ>.

Xerri, D (2016) The case for multimodal learning and teaching. *Modern English Teacher* 25(2): 13–14.

Xerri, D and Vassallo, O (eds) (2016) Creativity in English language teaching. Floriana: ELT Council. Retrieved from <https://goo.gl/9zi8Si>.

Xerri, D and Xerri Agius, S (2015) Galvanizing empathy through poetry. *English Journal* 104(4): 71–76.



# 6

## Sustainable Development Goal 5: Achieve gender equality and empower all women and girls

Jemma Prior and Tessa Woodward

### Introduction

In a world where we often treat girls and women less well than boys and men, gender inequality is expressed in a number of ways. Here are some of them.

- Parents with daughters may keep 'trying for a boy', female foetuses are aborted more often than males, baby girls are more often abandoned.
- Girls may be prevented from attending school.
- Girls suffer from child, early, underage and forced marriage.
- There is violence against women and girls in public and private spheres. This includes female genital mutilation (FGM), so-called 'honour killings' and rape used as a weapon of war.
- There is people-trafficking, and sexual and other types of exploitation.
- Barriers to employment, unequal pay and work, unpaid care and domestic work, unequal responsibility within the household.
- Lack of full, effective participation and of opportunities for leadership at all levels of decision making in political, economic and public life.
- Lack of access to sexual and reproductive health and reproductive rights.
- Unequal access to ownership and control over land and property, financial services, inheritance and natural resources.

Luckily, we also live in an era when there is a real will to do something about this state of affairs. As a result of the Sustainable Development Summit held in September 2015, world leaders adopted a set of 17 United Nations Sustainable Development Goals (SDGs) with 169 targets. These are designed to end poverty, fight inequality and injustice and tackle climate change by 2030. SDG 5 sets out to achieve gender equality and to empower all women and girls.

There are also movements, in many areas of the world, designed to support the swing towards gender equality. One example is the birth of the Women's Equality party in the UK. Another is the growth of organisations and websites that enable individuals to help each other via person-to-person lending, grassroots project support, sponsorship and citizen advocacy (Kristof and WuDunn, 2010: 252–4).

But what of us English teachers? What can we do? It is not, the present authors believe, a question of solving the global problem of oppression, the mere thought of which can daunt and defeat us. It is rather a question of understanding how we, in our daily work, can make a real difference in the lives of our students and those they know. As teachers, we have an opportunity and a duty to create an atmosphere and to give students in our classes, no matter what their gender or background, the experience of being in an inclusive, safe, fair environment, and of learning facts about, and the social and linguistic tools for, the empowerment of women and girls.

We teachers can do this by taking care in the following areas:

- Make sure that the physical organisation of the class and students is fairly distributed between female and male students.
- Ensure that our own question, answer and correction policies are balanced and fair.
- Ensure that the amount of 'air time' we give to each student is fairly distributed between female and male students.
- Ensure balance in the lesson topics we choose, the materials and processes we use, our own use of language, the target language we choose to teach (e.g. the 'unisex' pronoun 'they', gender-neutral job titles) and our own attitudes towards and expectations of our students and our situation.

The learning and teaching materials available to us may indeed be biased in all sorts of ways, but we can adapt, reject, sidestep and supplement them. Alone with our students in class, many of us are lucky to be independent to some degree, so we can prepare them for new roles and new aspirations. We can also help them to become global citizens, who can employ gender-fair and gender-neutral language in order to navigate new situations and avoid social mishaps. (See Sudo, 2007.)

## Activity 1: Balancing the books

### Aim

- To critically consider the gender balance of our teaching materials

### Language focus

- Numbers, comparatives, discussion language

### SDG focus

- To notice if texts represent women as well as men, and as being able and capable of a full range of interests, traits and skills. Thus, to challenge orthodoxy

### Creative focus

- Learning to critique standard texts

Level Counting: any. Coding: A2 upwards.  
Qualitative analysis: B1 upwards.

Age Any

Time 30 minutes

### Preparation

- Collect enough learning materials (coursebooks, resource materials, etc.) for students to discuss.

### Procedure

- Students work individually or in pairs or small groups, each with a copy of the coursebook, supplementary text or set of photocopies used in class.
- Invite them to count features of the materials for gender balance. Some of the things you can ask them to count are the relative number of:
  - o women and men authors, women and men referred to in bibliographies
  - o images of women and men
  - o types of activity women and men are engaged in

- o times 'she'/'he', 'woman'/'man', etc. are mentioned, turns in conversations, and initiatory turns.
- Counting is fairly objective since it is likely that different people counting the same things in the same materials will come up with roughly similar numbers.
- Next, invite the students to code the materials.
- Here are some possible coding categories:
  - o active versus passive characters
  - o major versus minor characters
  - o stereotyped versus unsteretyped images
  - o areas valued or unvalued economically or intellectually in our society.
- With more time and students with more English, ask them to analyse the materials qualitatively. This helps them to arrive at a more complete picture of who a text seems to be aimed at and why.
  - o They look at juxtapositions of image and text, at plot types, at characters and how they are depicted, what they say and do.
  - o They look at vocabulary and topic choice.
- Qualitative analysis is both very subjective and very revealing. It's the sort of work that activists in any minority or marginalised social group can do in a flash, and which those in the majority or dominant social groups take a long time to understand.
- Whether your students have simply counted or have gone on to code and qualitatively analyse their learning materials, encourage reporting and discussion of what they have found.

### Follow-up

- If you have access to a video or sound recorder or have a colleague willing to observe and take notes, you can count and code your own classroom interventions, counting, for example, the number of times you address, call on, correct or discipline female/male students; the number of times female/male students initiate an exchange; the length of utterances, number of interruptions of female/male students, etc.

## Activity 2: Who's the pedestrian?

### Aim

- To foster awareness of gendered language and teach and elicit different ways to avoid it.

### Language focus

- Words to refer to people in general, linguistic strategies for avoiding gender bias

### SDG focus

- SDG 5: Gender equality – Raises students' awareness of their own everyday gender assumptions, thus freeing the imagination

### Creative focus

- Gives strategies for using gender-neutral language

Level B1 and above

Age 16+

Time 50 minutes

### Preparation

- Images to illustrate the chosen scenario(s) with as many women in as possible. Possible sources for these, apart from an images search on Google, are:
  - o PhotosForClass – Search to download properly attributed, Creative Commons photos for school: <http://photosforclass.com/>
  - o Pixabay – Free images and videos you can use anywhere: <https://pixabay.com/>
  - o Freemages – a library of stock photography for use on websites, printed media, products and anywhere you need a photo to help with illustration and design: <http://www.freeimages.co.uk/>

### Procedure

- Elicit or teach general words for people in roles connected with the scenario you choose to use. For example:
  - o 'What do you call a person who ...?'
- rides a bike (a cyclist)
- rides a motorbike (a motorcyclist or biker)
- travels to work regularly (a commuter)
- walks in a town (a pedestrian)
- works in a shop (a shop assistant)
- walks past when an accident happens (a passer-by)
- sees what happens (a witness)

- Provide the class with a 'scenario' to discuss in pairs (see example below). The groups should come to an agreed position on what to do in the situation.
  - o An example might be: A pedestrian sees a cyclist lying on the road after having a road accident. There are other people around. What action should the pedestrian take?
- Students discuss the scenario. Once they have agreed on what to do, a spokesperson from each group summarises the group's findings to the rest of the class. Groups then discuss the suggestions.
- The pronouns students use to refer to the 'pedestrian' and 'cyclist' will often tend to be masculine (e.g. 'We think the pedestrian should check whether the cyclist is breathing and then he should phone for an ambulance ...').
- By showing a picture where the pedestrian and/or cyclist is a woman, you can bring the (inaccurate) assumption of male gender to the students' attention.
- Discuss how prevalent the assumption is and why it might be harmful to women and girls.
- Next, display a number of grammatically correct sentences referring generally to the action decided upon, e.g.
  - o If you find an injured cyclist, you should check his breathing.
  - o If you find an injured cyclist, you should check his or her breathing.
  - o If you find an injured cyclist, you should check her or his breathing.
  - o If you find an injured cyclist, check if s/he is breathing.
  - o If you find an injured cyclist, you should check they are breathing.
  - o If you find injured cyclists, you should check they are breathing.
- Ask pairs or groups of students to discuss these correct sentences. Which versions do they prefer and why?
- Feedback from students on the sentences might mention that some versions are more inclusive, more cumbersome, harder to pronounce, more old-fashioned, etc. than others.
- Some students may remain unconvinced that the unisex 'they' is now widely accepted. Show entries from any grammar book published after about 1985!

## Follow-up

- For homework, ask students to write some thoughts and actions for a different scenario using inclusive language throughout.
- The words in the first stage of the lesson are all gender neutral. The next time you work on this topic, they will learn what to do about gendered job titles such as fireman, postman, chairman, actress, etc.

## Additional Resources

See Adrian Wallwork (1997) Discussions A-Z – A Resource Book of Speaking Activities. Advanced. Cambridge University Press: 32 for possible new skeleton scenarios.

## Activity 3: She’s a Policeman?!

### Aim

- To foster awareness of gendered language and teach and elicit different ways to avoid it

### Language focus

- Gender-neutral job titles

### SDG focus

- SDG 5: Gender equality - Raises students’ awareness of gendered job titles, frees their imaginations and aspirations

### Creative focus

- Gives students strategies for using gender-neutral language

Level B1+ and above

Age 16+

Time 50 minutes

### Preparation

- Images to illustrate the chosen jobs (see Additional resources)

### Procedure

- The whole class brainstorms job titles, for example:
  - o policeman / doctor / nurse / actress / salesman / nurse / teacher / postman / fireman / builder / pilot / secretary / engineer / midwife / architect, etc. Make sure some of the words marked as feminine come up by eliciting them, such as actress / stewardess / waitress / barmaid.

- Students work in small groups or pairs and are asked to put the words into two groups according to whether they are job titles for men or for women. This will certainly cause confusion and discussion, especially with the words marked as female (a man can’t be a barmaid!). But will students be happy with the idea of a woman being a policeman?
- Once the students have grouped them, compare as a whole class. Discuss which words are appropriate only for men and which only for women and which are appropriate for both (i.e. gender neutral). An interesting word is ‘midwife’. It may appear to relate only to a woman doing the job but, since it means the person who is with (mid) the woman giving birth (wife), it is in fact gender neutral.
- Ask the students whether women work in the police / put out fires / fly aeroplanes and whether men work as nurses and midwives.
- As the answer is yes, give students a prepared list of job titles and ask how they can change the job titles to be more inclusive (this could be done as a dictionary or internet search).

Sexist job title	Neutral job title
policeman	
salesman	
actress	
postman	
fireman	
stewardess	
waitress	
chairman	
businessman	

Compare and discuss answers. Here are some possible alternatives: police officer / sales representative – salesperson / actor / postal worker – mail (letter) deliverer / firefighter / flight attendant / waiter – server / chair(person) / business executive.

- Focus students’ attention on the gender-neutral words, such as pilot, doctor, nurse, teacher, secretary, and in pairs ask them to do a visual internet search for these job titles. Ask them to compare in groups the images found according to how many depict men and how many women.



- Whole-class discussion topic – Why do men figure more as doctors and pilots and why do women figure more as nurses and secretaries? Discuss issues related to perceptions of men and women in the workplace and assumptions held in the students' own cultures.

- Finish with this story to illustrate how ingrained sexist assumptions are:

A father and his son were involved in a tragic car accident and the father was killed. His son was taken to hospital and, when he was wheeled into the operating theatre, the doctor exclaimed: 'Oh no, that's my son!' Why did the doctor say this?

(The doctor, of course, was the son's mother.)

### Follow-up

- For homework, ask students to write some job titles in their own languages that are gender neutral. If they can't find any because their language(s) don't work like this, they should find job titles that are masculine and see how they are used to refer to women.

### Additional resources

Google for image searches / online dictionary such as: <http://www.oxfordlearnersdictionaries.com/>

## Activity 4: Taking liberties

### Aim

- To raise awareness of the differences in civil rights for women and men

### Language focus

- Dates, timelines and their associated tenses, civil rights vocabulary

### SDG focus

- SDG 5: Gender equality – To help students to recognise a status quo and to question it

### Creative focus

- To understand the march of progress and to imagine a better future

Level B1 upwards

Age 16 years and upwards

Time 30 minutes

## Preparation

- Prepare a timeline or sequenced list of civil rights gained in a country you know. Please see Appendix for a link to an example list drawn from the UK. Keep one set of lists for students to check later. Cut the other sets into strips having removed the dates first.

## Procedure

- Elicit a list of important civil rights in a community, e.g. the right to vote, to drive, to go out alone, to be served in a restaurant or bar, to own property, to accept paid work outside the home, to choose a marriage partner, to become a member of parliament or mayor or prime minister, to enter professions such as law, medicine, architecture, etc.
- Ask students if they think these things are important to an individual and to a community and, if so, why.
- Ask them to state which country or which community they think these rights are most or least ensured for women. Then ask them when they think the rights were gained or will be gained in that community.
- Hand out to groups the strips of paper you prepared. Tell them the country that the strips relate to. Ask them to guess in which order the rights were gained and in which years.
- Once they have discussed the order of the strips and put their strips in date order, hand out the completed list for them to check against.
- Allow time for discussion of any surprises or comparisons with other countries – including their own.

## Follow-up

- Students can be encouraged to research the battles fought to gain particular civil rights (e.g. votes for women).

## Materials

(See link to possible list for abridging or simplifying in the Appendix below)

## Activity 5: Where are all the women?

### Aim

- To consider the balance of images of women and men in the public sphere and media

### Language focus

- Comparing, contrasting, describing everyday activities and objects, discussion language

### SDG focus

- SDG 5: Gender equality – Raises students' awareness of how, and how much, women and men are represented visually in public, and questions the prevailing orthodoxy

### Creative focus

- Learning to critique mainstream media images

Level Counting: any. Coding: A2+. Qualitative analysis: B1+

Age Any age

Time Depending on how many stages are used, 20–60 minutes

### Preparation

- Images of women and men from the students' cultures (from magazines, newspapers, advertising, banknotes, catalogues, etc.)

### Procedure

- Collect a selection of newspapers, magazines, catalogues and any other printed news or publicity material.
- Ask the students to browse through the material and to cut out all the pictures of women and men.
- Ask them to count the number of pictures/images of women and of men.
- Then ask them to code the pictures.
  - o Some possible categories for coding are:
    - active versus passive characters
    - major versus minor characters
    - stereotyped versus unsterotyped images
    - product/service advertised
    - types of activity women and men are engaged in.
- Ask them to analyse the pictures from a qualitative perspective, using the specific language for the pictures (occupation, activity undertaken, product/service being advertised, etc.). You can either teach the language elements needed or elicit them from the students before this analysis stage. This analysis can help with the practice of functions such as

describing, comparing and contrasting, and evaluation (e.g. 'This picture shows a woman vacuuming the carpet, whereas the other picture shows a man driving a car.'). These functions are often tested in international English language examinations, such as the oral components of the Cambridge English Preliminary and First exams.

- Further stages could be:
  - o a discussion on how women and men are represented in these materials and why this is the case
  - o if there are materials that are depicting women and men not doing stereotyped gender activities, why this is the case (it would be useful to analyse where the images originate from and what their purpose is).

### Follow-up

- Ask students to bring in more pictures of women and men from their own culture and society. Compare whether the stereotypical patterns of representation in the material initially used are similar or different.
- Ask them to find pictures from other sources, such as on banknotes, stamps, commercial catalogues, company/institutional brochures, travel brochures, websites, etc. to analyse and discuss gender imbalance.

## Activity 6: 1 – 2 – (maybe) 3

### Aim

- To consider the imbalance of famous or influential women and men in various sectors of society

### Language focus

- Vocabulary of professions, language of biographies, narrative tenses

### SDG focus

- SDG 5: Gender equality – Raises students' awareness of how and how much women have contributed to all sectors of society and culture throughout history

### Creative focus

- Learning to understand and appreciate the role of famous women in society

Level B1+

Age Any age

Time 30 minutes

## Preparation

- Prepare a worksheet with a list of sectors of society (see below for an example).

## Procedure

- Tell the students you are going to discuss famous achievements and famous people in history and in modern times.
- As a whole class, ask students to brainstorm the names of three famous people (either internationally or from their own countries) in the following areas:
  - o science / politics / film – TV / sport / business / art / literature, etc.

• science	• 1 • 2 • 3
• politics	• 1 • 2 • 3
• film/TV	• 1 • 2 • 3
• sport	• 1 • 2 • 3
• business	• 1 • 2 • 3
• art	• 1 • 2 • 3
• literature	• 1 • 2 • 3
• other	• 1 • 2 • 3

- After a few minutes, collect all the suggestions. (Most of the names will probably be men's.)
- Point out that there are not many women's names. Discuss why this is.
- Repeat the brainstorming, but this time ask them to write down only the names of famous women in these sectors.

- After a few minutes, come back as a class and collect the names. Have they been able to find three names for each sector? If they haven't, invite them to find out the names of nationally and/or internationally famous women in these sectors. This can be done online in class or for homework for the next lesson (see links below).

## Follow-up

- Provide students with either the names of famous women from some/all of the sectors you used before or names that came up in the brainstorming stage. Ask them to find out about one or more of these women and prepare class posters or presentations. Examples can be found at the links listed below.

## Additional resources

### Biography Online

- A list of the top 100 famous women: <http://www.biographyonline.net/people/famous/100-women.html>

### Bio

- Female leaders: <http://www.biography.com/people/groups/famous-female-leaders>

### Forbes

- The world's 100 most powerful women: <http://www.forbes.com/power-women/>

## Further resources

Aydınoğlu, N (2014) Gender in English language teaching coursebooks. *Procedia – Social and Behavioral Sciences* 158: 233–239.

Banyard, K (2010) *The Equality Illusion*. London: Faber and Faber.

Cameron, D (1990) 'Demythologizing sociolinguistics: Why language does not reflect society', in JE Joseph and TJ Taylor (eds), *Ideologies of Language*. London: Routledge.

Freeman, R and McElhinney, B (1996) 'Language and gender' in S McKay and N Hornberger (eds), *Sociolinguistics and Language Teaching*. Cambridge: CUP.

Hall, M (2014) Gender representation in current EFL textbooks in Iranian secondary schools. *Journal of Language Teaching and Research* 5/2: 253–261.

Hartman, PL and Judd, EL (1978) Sexism and TESOL materials. *TESOL Quarterly* 12: 383–393.

Jule, A (2007) *A Beginner's Guide to Language and Gender*. Clevedon: Multilingual Matters.

Kristof, N and WuDunn, S (2009) *Half the Sky*. New York: Vintage.

Lakoff, R (1975) *Language and Women's Place*. New York: Harper and Row.

Morgan, R (1977) *Going too far*. New York: Random House.

Sudo, J (2007) Teaching new tendencies in gender usage in modern English. *ELT Journal* 61/1: 12–19.

Sunderland, J (1992) Gender in the EFL Classroom. *ELT Journal* 46/1: 81–91.

Vetterling-Braggin, M (ed.) (1981) *Sexist Language: A Modern Philosophical Analysis*. Totowa, NJ: Littlefield, Adams and Co.

Wallwork, A (1997) *Discussions A-Z Advanced*. Cambridge: CUP.

Woodward, T (2003) Let there be you. Let there be me: Gender balance in ELT materials. *Folio: journal of the Materials Development Association*, vol. 8 1/2: 13–14.

## Weblinks

The Fair List, UK – ELT gender-balance initiative: [www.thefairlist.org](http://www.thefairlist.org) An ELT website encouraging balanced gender in plenary speakers and speaker panels at ELT, UK conferences.

Oxford Learners Dictionaries: <http://www.oxfordlearnersdictionaries.com/>  
An excellent online dictionary.

The Women's Equality Party – a new political party in the UK: [www.womensequality.org.uk](http://www.womensequality.org.uk). The Women's Equality Party is a new collaborative force in British politics uniting people of all genders, diverse ages, backgrounds, ethnicities, beliefs and experiences in the shared determination to see women enjoy the same rights and opportunities as men so that all can flourish.

Oman-Regan. M. Space and Anthropology blog – Sexism in the Oxford Dictionary of English: <https://medium.com/space-anthropology/sexism-in-the-oxford-dictionary-of-english-6d335c6a77b5#ojahwxnti>. An interesting discussion on perceived sexism in recent editions of the Oxford dictionaries.

Biography Online – A list of the top 100 famous women: <http://www.biographyonline.net/people/famous/100-women.html> . An international list of famous women throughout history.

Biography Online – Female leaders: <http://www.biography.com/people/groups/famous-female-leaders>. Short biographies and videos about female leaders throughout the world.

Forbes – the Forbes list of most powerful women: <http://www.forbes.com/power-women/>. The most up-to-date list of powerful women from the influential American business magazine.

The Fawcett Society – A campaigning charity: <http://www.fawcettsociety.org.uk/> . This is the UK's leading charity campaigning for gender equality and women's rights.

## Appendix

Below is the start of a long list that will appear shortly on [www.thefairlist.org](http://www.thefairlist.org) under the Resources/Radio and Mixed links button. The list there could be abridged, its language simplified and/or its content made more international.

'Positive events for UK Women' timeline

Originally written for The Fair List, UK awards event 2014.

1867 The London Society for Women's Suffrage is formed to campaign for female suffrage.

1870 The Married Women's Property Act allows married women to own their own property whether married, divorced, single or widowed.

1902 A delegation of women's textile workers from northern England present a 37,000-signatory petition to Parliament demanding votes for women.

1903 The Women's Social and Political Union is founded in Manchester by Emmeline Pankhurst, her daughters Christabel and Sylvia, and Annie Kearney.

1906 The National Federation of Women Workers is set up by Mary MacArthur.

# 7

## Sustainable Development Goal 6: Ensure availability and sustainable management of water and sanitation for all

Wei Keong Too

### Introduction

Did you know that 22 March every year is World Water Day? Did you also know that 19 November every year is World Toilet Day? Celebrating World Water Day is unsurprising, but celebrating World Toilet Day might come as a surprise to some people because it is usually taboo to talk about what we do in the toilet. However, studies have shown that accessibility to clean toilets helps reduce the mortality rate among children and reduces national medical costs.

According to 'World Water Day 2016 Facts and Guidance', about 40 per cent of the world population experiences shortage of water resources, and an estimated 6,630,000 people do not have access to clean drinking water. These numbers are projected to increase in the future. It was reported in the UN Water 2015 Annual Report that nearly 2.4 billion do not use safe toilets and an average 1,000 children die of sanitation-related diseases every day. The consequences of unavailability of clean drinking water and sanitation affect not only personal health but also the productivity and well-being of a nation.

This chapter addresses Sustainable Development Goal (SDG) 6, Clean water and sanitation, and presents activities which develop students' awareness of the issue as part of learning English. Water is a necessity in life. We drink water to keep us hydrated and healthy. We use water for our personal hygiene and to perform daily chores. Suffice it to say that access to clean water and sanitation is a basic human right. Yet, we take it for granted most of the time.

The objective of the activities in this chapter is to generate awareness of SDG 6. They are primarily intended for secondary school students. The activities engage the students with everyday reality through observation and examination of their own and others' daily practices, interactions and communication. Students are asked to record and analyse data to enhance their understanding of these issues. Examining personal behaviours or

surroundings also helps students to engage with unfamiliar issues or practices which they all too often take for granted and helps develop empathy for those less well provided for.

The six activities in this chapter can be used as a sequential unit or as individual lessons because each activity has a different topic and language focus. The importance of establishing trust is important in ensuring student participation.

Various levels of Bloom's taxonomy are used to underpin the activities (see Krathwohl, 2002). Various language forms can be incorporated into the six levels of the taxonomy, such as remember, understand, apply, analyse, evaluate and create.

The activities can be adapted to different proficiency levels. For proficient students, instructions and tasks are given in English. Such students will engage directly with English through activities such as reading newspaper articles, researching online information and interacting with peers. Less proficient students are given support in the form of handouts, such as vocabulary lists and grammar structures.

Maley (2015: 6) considers that 'creativity is born of discipline and thrives in a context of constraints'. The creative elements in these activities derive from constraints, which are presented as one of the task requirements, usually the level of demand of the end products.

### Activity 1: Where does fresh water come from? How do we store it?

#### Aim

- To get students to think about the distribution of water on our planet and identify the percentage of fresh water on Earth that is available for human use
- To think about the sources of fresh water and how we can store it

## Language focus

- Practice percentages and decimals in English
- Comparisons
- Vocabulary related to fresh water and its storage

## SDG focus

- SDG 6: Clean water and sanitation – Especially equitable access to safe and affordable drinking water for all

## Creative focus

- To think critically about the sources of fresh water and how it is consumed in the world via in-class and homework projects

Level B1–B2  
Age 14+  
Time 90 minutes

## Preparation

- Prepare a glass of fresh water, ideally so that everyone can see the water clearly.
- One copy of Worksheet 1 per group of four students
- A metre-long strip of adding machine paper per group
- A ruler per group
- Colour pens or pencils per group
- One sheet of cardboard paper per group

## Procedure

- Show students the glass of fresh water. Explain that although water is a recyclable resource – we can, to some degree, clean and reuse it – it is not a renewable one – we are not able to create more of it.
- Put them into groups of four students. Show them the world globe (for example, here: [http://www.cartagram.com/wp-content/uploads/2012/12/gallery\\_vandy.jpg](http://www.cartagram.com/wp-content/uploads/2012/12/gallery_vandy.jpg) or a real one if it is available at your school). Ask them how much of the world's surface is covered by water (70 per cent).
- Write on the board these four categories of water: frozen, underground, oceans, surface. Distribute one copy of Worksheet 1 per group and give them some time to label it.

- Ask them to present their answers. Write on the board the correct answers: 97% oceans, 2% frozen, 0.7% underground, 0.3% surface. Check if any group has got all the answers right.
- Give each group the strip of paper, a ruler, and the colour pens or pencils.
- Have the students calculate the length of the paper that represents each category. In order to do this, they need to convert each percentage into a decimal. For example, frozen:  $2\% = 0.02$ . The calculation is then:  $100 \text{ cm} \times 0.02 = 2 \text{ cm}$ .
- Ask students to colour each category a different colour so that they are easier to distinguish, label them and compare their papers with all the groups.
- After comparing their papers with all the groups, ask them which categories represent fresh water (all of them but oceans). Ask them to throw away the paper that represents oceans.
- In their groups, ask them to think of all the sources of fresh water and write on their strips of paper. Give them some time to discuss and write their answers on the board, for example: rain, glacier melt, artesian water from deep inside the earth, from desalination plants, recycling sewage, waste water, etc.
- Give one sheet of cardboard or paper per group. They are now to make a poster about where water comes from and how it is stored. Ask them to glue the strips of paper with fresh water sources written on them on the poster. Ask them to present their posters to the class, discussing their results.

## Follow-up

Search the internet, answer the questions and present as a group in a following class:

- Project 1: How much water per head is consumed in five different countries? How can we make sure this distribution is more equal? Ask them to use the ones they listed in class and compare their guesses with reality.
- Project 2: How can we store water? What are some ways we can be careful to preserve this water?

## Materials – Worksheet 1: Graph

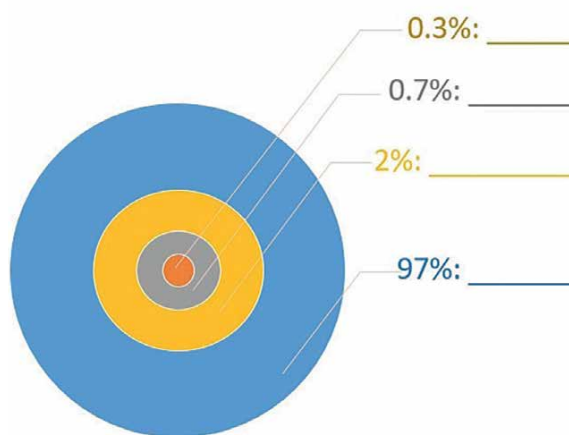

### Additional resources

UN Sustainable Development Goal 6

- Water facts and figures, links, news, and related videos: <http://www.un.org/sustainabledevelopment/water-and-sanitation/>

Seametrics

- A teacher's guide to water-related lesson plans and materials: <http://www.seametrics.com/water-lesson-plans>

The USGS Water Science School

- Information about typical water use at home: <https://water.usgs.gov/edu/qa-home-percapita.html>
- Information about the water cycle: <https://water.usgs.gov/edu/watercyclefreshstorage.html>

UN Water

- Proposed indicators for water- and sanitation-related targets: <http://www.unwater.org/sdgs/indicators-and-monitoring/en/>

ChartBins

- This map shows total water withdrawal per capita by country. Water withdrawal is the quantity of water removed from available sources for use in any purpose: <http://chartsbin.com/view/1455>

Green Facts

- An introduction to pressures on water resources: <http://www.greenfacts.org/en/water-resources/>

## Activity 2: Do we waste water?

### Aim

- To analyse classmates' water usage

### Language focus

- Comparative and superlative adjectives
- Question forms: How much? How many?

### SDG focus

- SDG 6: Clean water and sanitation – Encourages the discussion of the issue of water wastage and conservation

### Creative focus

- The students are asked to develop questions for data collection.

Level B1–C2

Age 13+

Time 60 minutes

### Preparation

- Read resources on how to save water at: <https://www.watercorporation.com.au/save-water>

### Procedure

- Have a group class brainstorming session around these questions.
  - o How much water do you use each day?
  - o Which activity wastes the most water?
- In groups of four, students create at least ten questions about their daily personal water usage. For example:
  - o How many times do you wash your hands every day?
  - o How many times do you flush a toilet every day?
  - o How much water do you use for ...?
- Each group joins another group and exchanges their questions. Together they decide which questions are the best and come up with a final list. There is no limit on the number of questions.
- Students form pairs with classmates who were not in their group. They take it in turns to interview each other, using their group's list of questions.
- They then present the interview information to the whole class.

## Follow-up

- Students each have to submit a piece of writing based on their own water usage and on their classmates' water usage using the data they collected in the interview.

## Additional resources

Water Corporation Western Australia

- Resources on how to save water: <https://www.watercorporation.com.au/save-water>

WaterAid

- WaterAid is an international organisation whose mission is to transform the lives of the poorest and most marginalised people by improving access to safe water, sanitation and hygiene: <http://www.wateraid.org/>

## Activity 3: How much water does my family use?

### Aim

- To analyse domestic water usage

### Language focus

- Active and passive voice

### SDG focus

- SDG 6: Clean water and sanitation – Focuses on appropriate ways to deal with water wastage and conservation

### Creative focus

- The students are asked to write a news report about their family members' use of water.

Level B1 to C2

Age 13+

Time 120+ minutes

### Preparation

- A week before the class, ask students to complete Worksheet 1 on water consumption in their house and bring the results to this class.
- Prepare copies of Worksheet 2 for 'News report analysis' below.
- Select a news article for the task sheet. Adapt the news article if necessary to match your students' level of proficiency.

## Procedure

- Start lesson 1 with the students brainstorming these questions:
  - o What is news?
  - o What makes a good piece of news?
  - o What ethical guidelines do we need to follow when we report a piece of news?
- In groups of four, ask students to read a newspaper article (or extract) and then complete Worksheet 2. For a possible article, see: <http://www.emag.suez-environnement.com/en/access-drinking-water-sanitation-fundamental-universal-human-right-7437> Or choose one you think will be more suitable for your class.
- Get students to discuss the answers from Worksheet 2.
- Discuss with the class any features they noticed about the use of language in news reports:
  - o What are the main features? Pay special attention to use of active and passive voice.
- Individually ask students to write a news report about their family members' water usage. They are to use the information they collected for Worksheet 1 and follow the guidelines for writing an article in Worksheet 2.
- In the next lesson put students into pairs. Ask students to exchange their news report from lesson 1 with their partner.
- While reading their partner's news report, they need to check if their friends have included all the elements of a news report, comment on what they like about the report and offer ideas for improvement.
- Ask students to share their news report with the class and to paste their news report on the noticeboard display.

## Follow-up

- Students read the reports on the noticeboard and vote for the best one. The criteria are as follows:
  - o The news items attracted my interest.
  - o The article answers all five W and the one H questions in the worksheet.
  - o The language used is appropriate, with very few mistakes.



## Worksheet 1: Water consumption questionnaire

<p><b>Please collect the following information.</b>  <b>Bring the completed worksheet with you to class.</b></p>	
<p><b>Basic information</b></p>	
• How many people live in your house?	
• How many bathrooms do you have?	
• How many toilets are there?	
• Is the house connected to a public water and sewage supply? If not, is there a septic tank? If not, where does the waste water go?	
<p><b>Water consumption data</b></p>	
• Is there a dishwasher? If so, how many times a day/week is it used?	
• If not, roughly how much water is used for washing up dishes and preparing food per day?	
• Is there a washing machine? If so, how many times a day/week is it used?	
• If not, roughly how much water is used for washing clothes per week?	
• How much water is used when a toilet cistern is flushed? (See: <a href="http://solutionelements.co.uk/Downloads%20copy/WCstate%20of%20the%20art.pdf">http://solutionelements.co.uk/Downloads%20copy/WCstate%20of%20the%20art.pdf</a> )	
• Roughly how many times a day are toilets flushed in your house? How much water is that (in litres)?	
<p><b>Which of these water-saving practices are used in your house?</b>  <b>Put a tick or a cross.</b></p>	
• Washing-up and food-preparation water is collected in a bucket and recycled to water the plants.	
• There is a water tank outside which fills from water from the roof when it rains. This is used to water the garden or wash the car.	
• All taps are turned off when not in use (e.g. when cleaning your teeth, the tap should be turned off while you are brushing; you should not do the washing up under a running tap – use a bowl).	
• People take five-minute showers rather than baths.	
• The dishwasher is only used when it is filled to capacity.	
• The washing machine is only used when it is full to capacity.	
• The toilet cistern is reduced in size by putting a brick or bottle in it.	

## Worksheet 2: News report analysis

Read the news article and fill in the blanks

Part I: Information in the news
Who:
What:
When:
Where:
Why:
How:

Part II: Elements of a news report		
Elements	Definition	Examples from the news
Headline	A title that summarises the news	
Byline	Name(s) of reporter(s)	
Placeline	Location that the event took place	
Lead	First paragraph that answers most of the five W questions	
Body	Subsequent paragraphs that provide more details	
Fact	The information is true	
Quotation	Statements from people	

### Additional resources

Unwater

- Facts and trends on water usage:  
[http://www.unwater.org/downloads/Water\\_facts\\_and\\_trends.pdf](http://www.unwater.org/downloads/Water_facts_and_trends.pdf)

Society of Professional Journalists

- The code of ethics: <http://www.spj.org/ethicscode.asp>

## Activity 4: How do we conserve water in our community?

### Aim

- To investigate how water is conserved in the community

### Language focus

- Direct and indirect speech

### SDG focus

- SDG 6: Clean water and sanitation – Relating the discussion on water conservation to the community

### Creative focus

- Students are asked to create a video news bulletin.

Level B1–C2

Age 13+

Time 3 classes of 60 minutes

### Preparation

- Prepare Worksheet 1: Script writing for news bulletin.
- Record a one-minute news video clip/radio news from your own TV or radio. Find a 30-word news article from a newspaper or magazine.
- Prepare a note to students' parents asking permission for them to be involved in the video clip task and to interview members of their communities.
- Collaborate with a colleague who knows how to use a free video-editing app to give a lesson for the students outside class.

### Procedure

- Show the news video clip and display the short news article you have chosen. Ask students:
  - o Which medium of news do you find more attractive?
  - o Why?
- Announce to the students that they are to create a news bulletin using their mobile phones. The theme is 'How does my community conserve water?'
- Show the video clip 'How to make a news package': <https://www.youtube.com/watch?v=6nDwW1BhZgo>.
- If your students do not have mobile phones, you can ask students to create a radio news script.
  - o Distribute Worksheet 1: Script writing for a news bulletin and explain the concept of news.

- o Discuss the features of direct and indirect speech by using the news article used at the beginning of the class.
- In groups of four, students brainstorm ideas on which news item to develop.
  - o What areas of conservation are we reporting on?
  - o Who are involved in the conservation?
  - o Where does it take place?
  - o Why have the people chosen this conservation method?
- Students submit a draft of their script in the following week.
- Arrange a lesson with a colleague to give a tutorial on video editing after school.
- In the next lesson students exchange their draft with another group. They comment on the following elements of the draft:
  - o Is there enough information for the five Ws and one H?
  - o Are the tenses used correct? Have they used the correct direct and indirect speech features?
  - o What do you like most about the script?
  - o How can the draft be improved?
- Leave time for students to ask for further clarification on script writing.
- Now allow students at least one week to record their news bulletin/radio news.
- In the next lesson students share their news bulletin video/radio news in class, and ask questions about and discuss the news.
- Ask students to vote for their favourite news bulletin video/radio news using the following criteria:
  - o The news items were interesting.
  - o The news contained answers for the five Ws and one H.
  - o The language was appropriate with very few mistakes.
  - o The news reporter's diction was clear.
  - o It was technically good: clear images and sound.

## Materials – Worksheet 1: Script writing for news bulletin

Complete Part I before you attempt Part II.

<b>Part I: Five Ws and one H</b>
Who:
What:
When:
Where:
Why:
How:

### Part II: Script-writing template

This template is designed for a one-minute bulletin. Write one word in each box. Three words are considered one second.

Adapted from: [http://news.bbc.co.uk/2/shared/bsp/hi/pdfs/30\\_08\\_06worksheet3.2.pdf](http://news.bbc.co.uk/2/shared/bsp/hi/pdfs/30_08_06worksheet3.2.pdf)

## Additional resources

BBC – School Report

- Script-writing tips and real examples: [http://news.bbc.co.uk/1/hi/school\\_report/6180944.stm](http://news.bbc.co.uk/1/hi/school_report/6180944.stm)

## Activity 5: Who has the right?

### Aim

- To raise awareness about human rights issues in accessing clean water and sanitation

### Language focus

- Narrative language

### SDG focus

- SDG 6: Clean water and sanitation – How access to clean water and sanitation is a basic human right

### Creative focus

- The students create images based on their interpretation of a task.

Level B1–C2

Age 13+

Time 60 minutes

### Preparation

- Look for video clips which show the crisis of water and sanitation which you can use in the classroom. Video clips in: <http://www.unwater.org>.

### Procedure

- Discuss the following with the class:
  - o Does everyone in the world have access to clean water and sanitation?
  - o Should we all have equal rights to access them?
- Play the video clip on the water and sanitation crisis. Ask students to think about the following two questions while watching the video:
  - o Why is access to clean water and sanitation important?
  - o Can we deny others the right to clean water and sanitation? Why?
- Working in groups of four, ask students to create a scene about human rights in relation to access to clean water and sanitation. Ask them to create a freeze-frame/tableau.
- As each group performs, one classmate from another group takes a photo of the freeze-frame.

- After each performance, the class can answer the following questions:
  - o What is the theme of the scene?
  - o Who are the people in the frame?
  - o What are their relationships?
  - o What is happening in the scene?
- Each group can post the freeze-frame photo on social media. They are encouraged to tag all group members and the teacher by using the tag, #waterishumanright. (If you do not have access to social media, omit this stage.)
- Groups can reconstitute their freeze-frame/tableau, but this time add words. Each person in the tableau can have one sentence to say which relates to their place in the frame.

### Follow-up

- In their groups, students can create a one-minute video on raising awareness about access to clean water and sanitation as a human right. If they do not have access to video, they can play the sequence live to the class.

### Additional resources

Water.org

- Facts about water and sanitation: <http://water.org/water-crisis/water-sanitation-facts/>

## Activity 6: What can we do?

### Aim

- To create awareness about SDG 6

### Language focus

- Descriptive language, narrative language, active and passive voice, and direct and indirect speech

### SDG focus

- SDG 6: Clean water and sanitation – This activity emphasises students' personal connection with SDG 6.

### Creative focus

- Students create a promotional video/poster on SDG 6.

Level B1–C2

Age 13+

Time 60 minutes

## Preparation

- Familiarise yourself with issues already raised in SDG 6.
- Liaise with the school to organise a sharing session to provide an opportunity for the students to showcase their work.

## Procedure

- Tell students that they are going to create an awareness campaign about SDG 6 by creating a promotional video/poster.
- Show them the video 'How to make a video': <https://www.youtube.com/watch?v=nGDJI11vnMA>.
  - o If your students do not have access to video-making equipment, you can ask them to create a poster.
- Inform them that they are going to present their work in English to other students. The audience will vote on the best video/poster.
- In groups of four, students pick a perspective on SDG 6 which they want to focus on in their video/poster.
- Ask students to brainstorm slogans/tags, storylines/images, scenes, etc.
- Get them to explore resources, such as video-making apps/mediums to create the video/poster.
- Encourage them to discuss the language features needed in the video/poster.
- Make sure they designate roles in the creation of the video/poster.
- Get them to start drafting their ideas and write and rehearse the script.
- Ask them to act out their video or design and execute the poster. Allow one week for this, during which time groups will consult with you at least once.
- Organise a time and place for the performance.

## Further resources

UN Water – The United Nations Inter-Agency Coordination Mechanism for All Freshwater Related Issues, Including Sanitation: <http://www.unwater.org/>

This website provides the latest news and publications on UN Water.

### World Toilet Day

- The official World Toilet Day website which provides resources for teaching: <http://www.worldtoiletday.info/>

### World Water Day

- This website provides good reading texts and ideas for language teaching: <http://www.unwater.org/worldwaterday>

### EarthEasy

- Twenty-five ways to conserve water in the home and yard: [http://eartheasy.com/live\\_water\\_saving.htm](http://eartheasy.com/live_water_saving.htm)

## References

Krathwohl, DR (2002) A revision of Bloom's taxonomy: An overview. *Theory into practice* 41(4): 212–218.

Maley, A (2015) 'Overview: Creativity – the what, the why and the how', in A Maley and N Peachey (eds), *Creativity in the English language classroom*. London: British Council, 6–13.

# 8

## Sustainable Development Goal 7: Ensure access to affordable, reliable, sustainable and modern energy for all

Phil Wade

### Introduction

Our society is powered by energy. Many of us take it for granted that with the flick of a switch we'll have electricity on demand 24/7. Yet not everyone in the world is as lucky. According to the International Institute for Environment and Development, 'one in five people around the world – 1.3 billion people – lack electricity to light their homes or run their businesses'. This is a shocking figure for the modern age, and as developed nations push forward, less developed countries are being increasingly left behind simply because they lack power. We can call this a power divide, and it grows larger every year.

This chapter focuses on SDG 7 which concerns the access to affordable, reliable, sustainable and modern energy for everyone on our planet. It also covers SDG 7.b, which is about providing the essential infrastructure and technology for energy supply for specifically less developed and small island states. By addressing these challenges, countries have the opportunity to pull themselves up out of the darkness and to push towards a bright future for their citizens. The activities in this chapter aim to engage students by placing them at the centre of several situations based on the SDG challenges. By making the problems real for them they will grasp their importance and understand the difficulties countries, companies and people are currently facing and will face before they are solved. The decision-making aspects help bring home to students how important good choices are regarding energy and how they affect everyone. The pair and group work elements make the activities social and appealing to a wide range of personalities and backgrounds. Students will quickly comprehend that they cannot solve the SDG challenges on their own and this realisation will help them understand the importance of our global community working towards the goals for a future where energy is no longer a problem but a solution.

Reference: <http://tinyurl.com/l48ayap>

### Activity 1: Make a town

#### Aim

- To understand how important energy is on an island

#### Language focus

- Making suggestions
- Language for agreeing, disagreeing and discussing ideas
- Language of for/against, benefits/ disadvantages
- Presentation skills

#### SDG focus

- Covers SDG 7 and 7b by asking students to build small functioning islands with access to modern, sustainable and reliable energy

#### Creative focus

- Creative thinking about the essential infrastructure of the islands

Level B1  
Age 12+  
Time 30 minutes

#### Preparation

- You will need one piece of A4 or A3 paper per group.

#### Procedure

- Ask students to work in groups of two to four.
- Give each group a piece of paper and a thick marker or pen.
- Explain that you want them to create and draw an island for 1,000 inhabitants.
- Elicit examples of what important things you need in a town and write them on the board, for example: power stations, water treatment plants, roads, hospitals, schools, housing, companies and farms.

- As they work, monitor and help students with any difficulties with vocabulary or ideas.
- When they have finished, explain to the class that their populations use too much electricity and their power stations cannot meet the demand, so they must build two more but not in very populated areas. Give them two minutes to decide where to build them.
- Ask each group to present their islands to the class.
- Write 'How important is energy?' on the board and tell the groups to discuss it together.
- Elicit a few answers and then ask what their life would be like without energy.

### Follow-up

- Tell the students to write a paragraph about how they would cope without electricity for a week.

### Additional resources

Plant It Green – Build Your Own City

- This is an engaging game students can play to build and maintain a city: <http://www.planitgreenlive.com/en/build-your-own-city>

## Activity 2: Reliably unreliable energy

### Aims

- To understand the importance of reliable energy
- To analyse characteristics of energy and select sources appropriately

### Language focus

- To present persuasive arguments
- To question and criticise and deal with objections
- To analyse pros and cons of an issue

### SDG focus

- This task relates to SDG 7, centring on reliable, modern and sustainable energy access.

### Creative focus

- To learn to critically understand, present and debate creative ideas as a stakeholder in the energy sector

Level B1  
Age 14+  
Time 1 hour

## Preparation

- You will need one piece of A4 paper or card per group, folded in half in landscape style.

## Procedure

- Tell the students you had to cancel a test last week and a lesson yesterday because the electricity supply did not work in the school so there was no lighting.
- Explain to the students that the local coal energy plant is unreliable. It cannot supply energy all day every day, and people are angry about it.
- Explain that there will be a public meeting in the class in five minutes with the local council to solve the problem and the students will represent different interested groups.
- Put students into pairs or threes, allocate the following roles and tell them their main objective individually.

### Roles

1. The city council – wants to find a reliable, affordable and sustainable solution as soon as possible.
2. Local residents – want a reliable solution now that will not raise their electricity bills.
3. Greenpeace activists – want a sustainable and environmentally safe solution.
4. A pressure group for nuclear energy – wants to sell a nuclear power plant.
5. A company providing hydroelectric power – wants to sell a hydroelectric power plant.
6. A company providing biogas power – wants to sell a biogas power plant.

- Ask each pair or group to write their title on their paper or card and put it in front of them on their table for all to see.
- Remind them that this is a public discussion but the council needs to find a solution, so the other groups must persuade them and also the residents. They should also criticise the other groups. At the end of the meeting the city council must choose a solution.
- Tell each pair or group to prepare by noting down what to say and what questions to ask.
- Ask the city council to start by explaining the problem and the objective of the meeting.



- Go round each group and ask them to share their suggestions. Encourage others to ask them questions. Everyone takes notes.
- Ask groups to clarify any points you think were not clear or ask any important questions.
- Give each group (except the council) 30 seconds to make a final statement.
- Ask the city council to decide on a solution and explain why to the class.
- Congratulate the winning group.
- Draw five columns on the board with these headings: Affordable, Reliable, Sustainable and Modern.
- Write Nuclear, Hydroelectric, Biogas, Solar and Wind in the first column like the one below.

	Affordable	Reliable	Sustainable	Modern
Nuclear				
Hydroelectric				
Biogas				
Solar				
Wind				

- Tell students to brainstorm ideas for the other columns. Then ask each pair or group to add their ideas to the board.
- Ask students to look out the window at their town and to think of the people in it and what is the best choice for them.
- Hold a class vote by telling students to take a small piece of paper and to write the type of power plant they prefer for the town.
- Collect all the papers and ask for two volunteers to read the votes and another to add the numbers to the board.
- Ask for reactions from the students to the winning choice. Then share your own opinion.

### Follow-up

- Set up a debate between the nuclear energy pressure group and the Greenpeace activists.
- Ask students to interview their family about which power plant they would prefer and why. Then report back to the class.

### Activity 3: Keeping up with the demand

#### Aims

- To solve mathematical problems in English
- To develop effective decision-making skills
- To prepare and present an oral summary report

#### Language focus

- Language of calculations
- Problem-solving vocabulary
- Note-taking skills
- Presentation skills, including summarising and presenting decisions

#### SDG focus

- SDG 7, focusing on providing sustainable and reliable energy

#### Creative focus

- Students must think logically about numbers and make quick decisions by working effectively in a team.

Level B1  
Age 16  
Time 30 minutes

#### Preparation

- Write the two lists/tables (A and B) on the board before the lesson to save time. Provide one dice for each group.

#### Procedure

- Elicit sources of alternative/sustainable energy sources.
- Put the students into groups of two to four.
- One half of the groups are producers of solar power and the other half are producers of wind energy.
- Explain that they will play a game where they have to supply a town with electricity for six days.
- Give them each a dice. Say that they must roll it first to find out the customer demand and a second time for the supply (refer to the lists below). Their job is to make sure they can meet the demand.
- Point to the tables on the board, read through the 12 points and check everyone understands them.
- Inform students that if they have too much supply, they can sell it, but if they do not have enough, they must buy some. The rate for selling electricity is \$10 kWh and for buying it is \$12 kWh.

- Give a quick example, e.g. if today's demand is 2,000 kWh but supply is only 500 for wind and 1,000 for solar. Do the calculation with them.
- Tell them to choose a group secretary to make notes of the group discussion and the solutions. Remind them to keep accurate records of how much money they made or lost each day.
- Explain that at the end they must present what they did, how much money they made or lost and how easy or difficult it was. Monitor and comment on the presentations.

#### A. Customer electricity demand

- 1= Very low demand: 300 kWh
- 2= Low demand: 500 kWh
- 3= Normal demand: 1,000 kWh
- 4= High demand: 1,500 kWh
- 5= Very high demand: 2,000 kWh
- 6= Incredibly high demand: 2,500 kWh

#### B. Energy supply

- 1= A storm: 2,500 kWh for wind turbines, solar 300 kWh
- 2= Strong winds: 2,000 kWh for wind turbines, solar 500 kWh
- 3= An average day: 1,500 kWh for wind turbines and 1,000 kWh for solar
- 4= A very sunny day: 2,000 kWh for solar, 500 kWh for wind turbines
- 5= Sunny but windy: 1,000 kWh for solar and 1,500 kWh for wind turbines
- 6= A heat wave: 2,500 kWh for solar, 300 kWh for wind turbines

- When groups have finished, allow them five minutes to prepare their report presentations .
- As each group presents, make notes of how much they made or lost.
- Ask the students which source of energy is the most reliable and which can make the most money.

## Follow-up

- Ask the students to read this blog post and watch the video at home: <http://blog.solarcity.com/island-in-the-sun/>. Then in class put these questions on the board and ask students to answer and discuss them in small groups.
  - o What was the project?
  - o Did it work?
  - o How could it be done here?
- Elicit as many ideas as possible.

## Activity 4: The city has problems

### Aims

- Problem-solving related to reliable, sustainable, affordable and modern power supply
- Brainstorming ideas and to reach agreement
- Critically comparing and contrasting solutions

### Language focus

- Making suggestions
- Vocabulary related to energy production and supply
- Comparative adjectives and phrases

### SDG focus

- Based on SDG 7

### Creative focus

- Challenge to tackle a variety of taxing and unanticipated challenges, quickly brainstorm and select appropriate solutions and then create a wall of possible solutions for analysis

Level B2  
Age 16+  
Time 50 minutes

### Preparation

- Move all the desks to the centre of the room or against each wall so that there is lots of space to move freely around the room. A room with no desks would also be perfect.

- Cut up the problems from the Materials section and put each one in an envelope. Put the number of the problem on the front – ‘problem 1/2/3’ etc. Stick each envelope to the wall with Blu-tack or tape, or place them on tables so that there is at least a metre between them and space for two people to stand and discuss.
- You will also need a pack of Post-it notes per group.

### Procedure

- Ask the students to think of a problem a city could have regarding power supply. Give an example, such as a power cut. Then elicit one possible solution, for example buy energy from a supplier.
- Point to the envelopes and explain that they contain ten problems about energy which need solutions.
- Give each pair a pack of Post-its and call them solution Post-its.
- Put the students into ten groups or pairs and tell them they are now engineers at the local energy production plant. Their envelope contains a problem. They will have to read it, brainstorm solutions and then select the best one and write it on a Post-it. They will have four to five minutes for this and then will move to the next problem.
- Tell them they must keep the Post-its and remember to add the problem number because they will need them later.
- Begin the activity by allocating a pair or group to each problem and asking them to open the envelope. Monitor them and give one-minute warnings.
- After four minutes, tell the students to put the problems back in the envelopes and to rotate clockwise to the next problem. Check that they have all written down their solutions.
- When they have finished the tenth rotation, tell the students to put them on the wall or leave them on the desk.
- Once this is done, ask them to circulate and read all solutions to each of the problems.
- When they have finished, groups/pairs stay at the problem they are at and compare their solution with the others and say honestly which they now think is the best.

## Materials

### Problems

1. The power station is hit by lightning and stops working.
2. Demand exceeds supply by 300% due to the World Cup final.
3. Many customers complain about your high prices and refuse to pay.
4. There is a protest outside the power plant by Greenpeace about your pollution of the air and water.
5. Your new president urges you to invest in sustainable energy but it will be expensive.
6. A cyclone arrives and damages the solar hot-water panels on 50% of local houses.
7. An explosion in the town centre cuts off the power.
8. A new competitor suddenly offers 30% cheaper prices.
9. Inspectors visit your plant and report that it is too old and needs updating.
10. There is an accident and the local river is polluted.

### Follow-up

- Ask the class which was the hardest problem to solve and why. Elicit one answer from each student.

## Activity 5: To be free or not to be free? That is the question

### Aims

- To reach a verdict in a court case about access to energy, involving construction and presentation of arguments
- Critical analysis of counter-arguments

### Language focus

- Closed and open questions
- Legal vocabulary and idiom

### SDG focus

- Focus on SDG 7 as it relates to the price of energy and the idea of access to energy for all

### Creative focus

- Imaginative role play

Level B1+

Age 14+

Time 50+ minutes

### Preparation

- Set up the classroom like a courtroom: a table at the front for the judges; a table on the right for the jury; a table facing the judge for the parties and seats at the back for the witnesses; a witness box to the left facing the judge.

### Procedure

- Elicit words from the students to do with crime and justice: criminal, innocent, accused, court case, lawyer, prosecution, defence, prove/proof, evidence, witness, sentence, jury and judge, etc. Write them on the board and elicit or explain their meanings.
- Ask for a volunteer to explain how a legal court case works. If nobody can, explain it step-by-step referring to words from the board. For example, a person is accused of a crime and they go to court. The prosecution and their lawyer try to prove the guilt of the defendant. They use witnesses and evidence. The defendant tries to prove their innocence. The jury decides and the judge gives a sentence.

- Explain that you will hold a court case in the class between the prosecution who represents angry energy consumers and the defence who represents the government's Energy Ministry. The prosecution accuses the defence of setting unrealistically high prices and wants energy to be free and a basic human right.
- Choose three students to be the judges; three, five or seven to be the jury; then one to three to be the prosecution lawyers, and the same numbers for the defence. Select at least two people for each side to be witnesses.
- Write and explain the following procedure on the board:
- Before the final closing arguments, choose a person from the jury in secret and tell them they are a new star witness. Give them a role that will completely change the outcome. For instance, they could be a sacked employee from the government who has emails showing they decided to increase prices, or they could be the old lawyer from the prosecution who quit because they found out the people they represent were paid by private companies to help privatise the energy sector.
- Announce the new witness and flip a coin for who will question him/her first.
- Continue with the final arguments and end the case.

#### Judicial process

- Opening statement from the judges about the case
- Opening statements from the prosecution and defence
- The prosecution's first argument with a witness
- Cross-examination by the defence
- The defence's first argument with a witness
- Cross-examination by the prosecution
- Continue until all the arguments and witnesses have been utilised
- Closing arguments from both sides
- The jury decides guilty or innocent
- The verdict and punishment from the judges

#### Follow-up

- Discuss the case and ask if the losing side should appeal and how. Also ask the students how we might supply free energy for all.

#### Further resources

TED videos – Sustainable energy

- A collection of interesting presentations about sustainable energy ideas and perspectives: <http://tinyurl.com/z6gtmvd>

NOVA labs – Energy Lab

- An engaging online game to design a renewable future for the US, some energy video quizzes and a range of short videos about energy: <http://www.pbs.org/wgbh/nova/labs/educators/>

- Give students ten minutes to talk to their partners and prepare. Tell the prosecution and defence to prepare their arguments by talking to their witnesses. Tell the jury to discuss what they need to know to decide the guilt or innocence of the defendant. Tell the judges to discuss what possible punishments they could give.
- Begin the case at step 1; time each on your watch or phone and also the preparation time if they need it. If either lawyer makes unjust allegations, leads the witnesses or becomes aggressive, tell the opposite team they can object and the judge has to accept or overrule. Then the lawyer must either apologise or continue.



# 9

## Sustainable Development Goal 8: Promote sustained, inclusive and sustainable economic growth, full and productive employment and decent work for all

Nik Peachey

### Introduction

United Nations Sustainable Development Goal 8 focuses on issues related to sustainable economic growth and fair employment. This is an enormously important goal and one that has huge implications across many elements of society around the world. Economic growth around the world must be based on the inclusion of all members of our societies and benefit every level of our society. At present we live in a world where according to Oxfam the wealth of the richest 1 per cent of the population is equal to the other 99 per cent, and the divide between rich and poor seems to be growing greater rather than getting smaller.

If this situation continues, it is possible that the kinds of social and political problems and violent crises that we are seeing at present will continue to grow and that world peace and stability will be increasingly threatened.

As teachers, it is part of our role to help our students to understand and address the kinds of issues being raised by the Sustainable Development Goals and look for solutions to these problems which are peaceful, inclusive, creative and fair.

In this chapter I have chosen to deal with four elements of SDG 8. These are:

- Youth unemployment – I do this through the medium of a discussion task followed by online research. Students share and develop their existing knowledge through a guided research task and then look at ways they can consolidate the knowledge and ideas they have developed in a constructive and informative way.
- Child labour – I do this through a combination of discussion and role play as means to helping students better understand and empathise with the situations of all of those involved in child labour.
- Access to financial services – I approach this by building an activity around a crowdfunding website which is used by individuals to raise money for small businesses. In the activity students see how people can help each other with very small amounts of money to improve their own lives.
- Sustainable tourism – In this activity I encourage students to explore some of the issues around tourism-based economies and some of the potential pitfalls that increased tourism can have for the people and cultures that become tourist destinations.

I hope you and your students find value in these activities and they help you to unfold some of the deeper issues within this goal.

### Activity 1: Youth unemployment

#### Aim

- To raise awareness of the problems and consequences of youth unemployment and to get students to think about possible solutions

#### Language focus

- Vocabulary related to unemployment

#### SDG focus

- SDG 8 – This activity attempts to raise awareness of element 8.6 of the goals, which focuses on reducing youth unemployment.

#### Creative focus

- Students are encouraged to think creatively about the solutions to some of the problems of youth unemployment.

Level B1+  
Age 14+  
Time 60–80 minutes

## Preparation

- Make copies of the research questions (Worksheet 1) for each student.

## Procedure

- Put the students into groups of four to five and write 'unemployment' on the board.
- Ask them to brainstorm words that they connect with unemployment and give them a two-minute time limit.
- Now get the students to share some of their words and explain the connection to unemployment.
- Now show them these three questions and ask them to find out what the others know about the problem.
  - o What do you know about levels of youth unemployment in your country?
  - o Which countries do you think have a problem with this?
  - o What other problems are connected with youth unemployment?
- Once again, have a whole-class discussion and get students to share what they know.
- Now ask students to do some research to find out more about the problem. Give them Worksheet 1: Research questions to focus their work.
- They can do the research at home for homework, in the classroom if they have internet access through mobile devices or in a computer lab if you have one.
- Tell them to make sure they make notes of the sources of the information they find.
- Once they have finished the research put the students into groups and tell them to share what they have learned and see if they have similar research results.
- Now ask them to create some form of presentation to inform other people about the problems and possible solutions to youth unemployment. They could do this in the form of a written report, infographic, video or slide presentation.
- Once they have prepared their presentations you could put the students into groups to present to each other and give each other feedback on their work.

## Materials

### Worksheet 1: Research questions

Do some research and find out the following:

- Which countries are affected by youth unemployment?
- What age groups are affected?
- How many people around the world are affected?
- Is the impact of the problem greater for males or females?
- What are the consequences of youth unemployment?
- What are some possible solutions?

Information sources:

## Additional resources

Statista – The State Of Global Youth Unemployment

- This site shows the global youth unemployment rate from 1995–2015: <https://www.statista.com/chart/3871/the-state-of-global-youth-unemployment/>

Peace Child – Youth Unemployment Causes and Solutions

- This site has some useful explanations of the causes and some of the solutions to the problem: <http://peacechild.org/youth-unemployment-causes-and-solutions/>

Youth Employment UK

- This site has a wide variety of resources and information for young people about how to find work: <http://www.yeuk.org.uk/>



## Activity 2: Child labour

### Aim

- To raise students' awareness of the extent of child labour and to deepen their understanding of some of the causes of the problem

### Language focus

- To develop speaking skills and persuasion skills

### SDG focus

- SDG 8 – This activity focuses on element 8.7 of the goals and in particular on the problems of eradicating child labour.

### Creativity focus

- The activity uses role play to build empathy with various parties involved in the child labour situation.

Level B1+

Age 14+

Time 60 minutes

### Preparation

- Make copies of Worksheet 1: Discussion questions and Worksheet 2: Role play. Cut up the role play cards so there is enough for one for each student.

### Procedure

- Start the lesson by asking if any of the students has a part-time job. If you have adult students, ask if they had a part-time job when they were at school.
- Ask them what the job was and whether they enjoyed it. Ask how many hours they did. Get students sharing their experiences.
- Now ask them if what they did was child labour. Put the students into groups of three to five and give them Worksheet 1: Discussion questions.
- Get them to discuss the questions in their groups and share their knowledge.
- Once they have had time to discuss the questions, just ask how many children they think are affected by child labour. Get their answers and then tell them that the official estimate is 150 million children.
- Tell the students they are going to do a role play about child labour and each one of them will have a part.
- Put the students into groups of four and give each one a role card from Worksheet 2. Make sure to give the strongest student Role 4: Activist role. This is also a good role to double up if your class numbers don't split equally into groups of four.

- Give students the chance to read their role card and make sure they understand all the vocabulary.
- Now start the role play by getting the students to introduce themselves in their role to the rest of their group.
- Once the students have had time to work through the role play, bring the activity to an end and ask the groups to feed back to you on the outcome of their discussion. Find out if any of the people in the group achieved their aims.
- Put students into groups and ask them to think of things that can be done to help end child labour around the world.
- After they have had some time to brainstorm ideas, pull the group together and collect suggestions.

### Follow-up

- Ask students to look at this page on WikiHow - How to Take Action to End Child Labor: <http://www.wikihow.com/Take-Action-to-End-Child-Labor> and evaluate the suggestions they make for helping to end child labour.
- Ask students to do further research into child labour and find out more about it. Ask them to use the information they discover to write a short article about it. This can be posted in a school newsletter or on a website.

### Materials

#### Worksheet 1: Discussion questions

Discuss these questions in your group.

- What do you know about child labour around the world?
- How many children do you think are affected?
- What kinds of work do you think they have to do?
- Why do you think businesses employ children?
- Why do you think parents allow their children to work?
- How do you think the children feel about working rather than going to school?

## Worksheet 2: Role play

### Role 1: You are a child

- You are 11 years old and you have to work ten hours a day.
- You have two younger sisters.
- You want to go to school.
- You want to learn about computers and get a good job when you are older.
- You don't have time to study.
- You are too tired and never play with your friends.

**Your aim:** Persuade your parent that you shouldn't work.

### Role 2: You are the parent

- You have three children and you can't earn enough money to feed them all and send them all to school.
- Your oldest son is 11 and you have sent him to work in a local factory.
- The money he earns helps to feed your family and enables you to send your two daughters to school.

**Your aim:** Persuade your child to keep working and get the businessman to pay him more money.

### Role 3: You are a business owner

- You have a small factory producing children's toys. The toys are exported to rich countries.
- You employ children to work in the factory because they are very cheap.
- You only make a small profit and there is a lot of competition from other toymakers.
- You don't like employing children, but all other factories do this.
- If you employ adults your costs will go up and you will go out of business.

**Your aim:** Persuade the parent that he should get his daughters to work in your factory as well as his son.

### Role 4: You are a political activist

- You want to help end child labour.
- Interview the people and find out about their problems and help them reach a solution.

**Your aim:** To make sure that the child gets the opportunity to go to school.

## Additional resources

### International Labour Organization

- This site has a wide variety of facts and statistics on the causes and problems of child labour: <http://www.ilo.org/global/topics/child-labour/lang--en/index.htm>

### Forbes

- This is an interesting article on child labour from a business perspective: <http://www.forbes.com/forbes/2008/0225/072.html>

### Save Our Children

- An infographic on types of child labour: <http://tinyurl.com/mjb5odh>

### Child Fund International

- This page has an infographic on the costs of child labour around the world: <https://www.childfund.org/child-labor-survey-infographic/>

### Activity 3: Access to financial services

#### Aim

- To make students aware of crowdfunding sites and methods poor people can use to get access to funding for businesses

#### Language focus

- Speaking and reading skills and vocabulary related to banking and investment

#### SDG focus

- SDG 8 – Many people in poorer areas of the world lack access to banking institutions and the kind of financial services that would enable them to improve their own lives. This activity raises awareness of some alternatives.

#### Creativity focus

- Imagining how to create your own business and building a sense of empathy with those trying to help themselves out of poverty

Level B1+  
Age 14+  
Time 60 minutes

#### Preparation

- This lesson is based around the <https://www.kiva.org/> website. The site specialises in helping people to crowdfund money to start or improve a small business. Make sure you familiarise yourself with the site.
- For this lesson your students will need to have internet access.
- Make copies of Worksheet 1.

#### Procedure

- Tell your students to try to imagine they are going to start their own business. Tell them they have very little money (if they ask you how much, you could say \$200), so it would have to be a very small business to begin with. Give them some time to think about what the business would be.
- Now put them into small groups to explain to the others what the business would be.
- Once they have had some time to do this, tell them that if they go to the bank and borrow money they could grow their business much more quickly. Ask them to think about how they could convince the bank to lend them money.

- Once they have had some time to discuss this, get some students to suggest ways they might convince the bank to lend them money.
- Now ask them how likely they think it would be that the bank would give them the money.
- Tell the students that lots of poor people have ideas for businesses but find it hard to get the money to make the ideas a reality.
- Now tell the students that there are websites where people can crowdfund money for their ideas. Explain that crowdfunding is collecting small loans of money from lots of different people. Tell them that this enables people to lend money to each other and help each other.
- Show the students the Kiva website and tell them that this is an example. It allows people to lend a minimum of \$25 to help other people improve their lives.
- Put the students into pairs and tell them you would like them to imagine that they have \$100 dollars. Give them a link to this part of the website: <https://www.kiva.org/lend>. Ask them to look through the different ideas people have and decide who they will lend the money to. Tell them they can lend all of the money to one person or split the money between as many as four people, but they have to justify their decision and agree together.
- Give them time to explore the site and decide which people they would like to help. Give them Worksheet 1 and ask them to complete the information about each person they select.
- Now get the students into small groups, or as a class get them to tell briefly who they want to fund, why and how much they want to give to each person.
- Finally, put the students into groups of around four students and get them to discuss these questions:
  - o What kind of people do you think lend money on this site?
  - o Why do you think they lend the money?
  - o Do you think they always get their money back?
  - o What do you think are the advantages/ disadvantages of using a site like this to raise money?
  - o Would you use a site like this?
  - o How did you decide which people to lend money to? What influenced your decision?

## Follow-up

- You could follow up this activity by getting students to write an imaginary entry for the site describing their business and setting a target amount they would like to raise. Once your students have written their entries for the site you could stick them up around the class and get the other students to read them and decide which ones they would lend money to.
- You can get the students to find out more about Kiva by going to: <https://www.kiva.org/about>. Ask them to research the site and write a short report about it for a school magazine or website.

## Materials

### Worksheet 1: Lending money

Name of borrower:				
Purpose of the loan:				
Loan target:				
How much they still need:				
How much you will lend:				
Reason for selecting this borrower:				

## Additional resources

### Wikipedia – Crowdfunding

- Wikipedia has a useful explanation of what crowdfunding is and how it works: <https://en.wikipedia.org/wiki/Crowdfunding>

### KickStarter

- Some useful statistics in this infographic about crowdfunding: <http://tinyurl.com/mwqjdr4>

### World Bank

- A useful article and infographic showing who and why so many people don't have access to banking: <http://www.worldbank.org/en/news/infographic/2012/04/19/who-are-the-unbanked>

## Activity 4: Sustainable tourism

### Aim

- To raise students' awareness of the benefits and potential dangers of the tourist industry

### Language focus

- To develop students' speaking and reading skills in relation to tourism

### SDG focus

- SDG 8 – As part of SDG 8 it is proposed that sustainable tourism be encouraged as a means of sustainable economic growth. This activity focuses students on some of the pros and cons of tourism and helps them to think about the elements that make tourism sustainable.

### Creativity focus

- To encourage students to think of ways to make tourism sustainable

Level B1+  
Age 14+  
Time 60 minutes

### Preparation

- Produce a presentation slide show with an image from each of the following places:
  - o the Galapagos Islands
  - o the Maldives
  - o the Great Barrier Reef
  - o Venice
  - o the Dead Sea
  - o the Alps
  - o Madagascar
  - o the Congo Basin
  - o Glacier National Park
  - o Taj Mahal.

You can find images for this presentation by searching on Google Images: <https://images.google.com/>.

### Procedure

- Give the students the travel quotes on Worksheet 1. Ask them to read the sentences and decide which ones they agree with and which they disagree with.
- Once they have had time to read, ask them to stand up and mingle and share their opinions about the quotes with other students. Tell them to try to find the people whose views are most similar to their own.

- Now put the students into pairs. Tell students A that they agree with all the statements and students B that they disagree with all the statements. Tell them to discuss each statement and try to convince the other person that they are correct. Set them a two-minute time limit to discuss each statement.
- Now put the students into groups of four and ask them to brainstorm a list of pros and cons of a tourism-based economy.
- Now show the students your slide show and ask the students which of the places they would most like to visit:
  - o the Galapagos Islands
  - o the Maldives
  - o the Great Barrier Reef
  - o Venice
  - o the Dead Sea
  - o the Alps
  - o Madagascar
  - o the Congo Basin
  - o Glacier National Park
  - o Taj Mahal.
- Once they have decided, give them a link to this infographic: <http://editorial.designtaxi.com/news-10plc0507/big.jpg>. Tell them to find the place on the infographic and find out how soon they will need to visit it and why.
- Once they have found the answers, ask them to look at the other places on the infographic and find out how many are threatened as a direct result of tourism.
- Now put the students into groups and ask them to think about how tourism could be made more sustainable. Ask them to think of advice that could be given to tourists to encourage them to do less damage to the places they visit.
- Once they have finished, show them this infographic on sustainable tourism and ask them to see how many of their own ideas are included on the infographic: <http://tinyurl.com/mzyrrhv>

## Materials

### Worksheet 1: Travel quotes

#### Which of these quotes do you agree with?

Tourism destroys the lives and places of the people the tourists go to see.

Tourism is one of the best methods of improving the economy of any country.

If you build your economy on tourism then a change in the weather can destroy your economy.

Tourism is about rich people going to see how poor people live.

Travel makes people more open-minded, tolerant and understanding of the cultures of other people.

Most people who travel abroad see very little of the real country or culture they visit.

#### Additional resources

##### Sustainable Tourism

- This site has information and resources on the impact of tourism as well as suggestions for how to make it more sustainable:  
<http://www.sustainabletourism.net/>

##### BBC – Bitesize

- This site has easy-to-read information about sustainable tourism aimed at teenagers: [http://www.bbc.co.uk/schools/gcsebitesize/geography/sustainability/sustainable\\_tourism\\_rev1.shtml](http://www.bbc.co.uk/schools/gcsebitesize/geography/sustainability/sustainable_tourism_rev1.shtml)

##### UNESCO – Teaching and Learning for a Sustainable Future

- This site has a range of activities and materials for learning/ teaching about sustainable tourism: [http://www.unesco.org/education/tlsf/mods/theme\\_c/mod16.html](http://www.unesco.org/education/tlsf/mods/theme_c/mod16.html)

#### Resource bank

##### UNDP

- This site has information and stories about real projects and the people involved in them and how the UN is attempting to achieve their goals: <http://tinyurl.com/n37rvmu>

##### LIDCUK

- This site has a short video explaining the sustainable goals: [https://youtu.be/NkAv9L1\\_r1M](https://youtu.be/NkAv9L1_r1M)

##### The Global Goals – 8 Decent Work and Economic Growth

- This site has a wide variety of information and media that students can download, use in projects and post to social media to express their support for the SDGs: <http://www.globalgoals.org/global-goals/good-jobs-and-economic/>

# 10

## Sustainable Development Goal 9: Build resilient infrastructure, promote inclusive and sustainable industrialisation and foster innovation

Malu Sciamarelli

### Introduction

According to the United Nations Sustainable Knowledge Platform,

*Goal 9 encompasses three important aspects of sustainable development: infrastructure, industrialization and innovation. Infrastructure provides the basic physical systems and structures essential to the operation of a society or enterprise. Industrialization drives economic growth, creates job opportunities and thereby reduces poverty. Innovation advances the technological capabilities of industrial sectors and prompts the development of new skills.*

Its targets are to:

- ensure that companies promote sustainable development and do not harm the environment
- develop sustainable and resilient infrastructure to support economic development and human well-being
- provide small businesses with access to credit and technical support for their development
- allocate resources for research to address that country's specific needs and improve technology
- ensure all have access to the internet and new technologies, especially those living in the least developed countries.

It is very important to educate students about the Sustainable Development Goals (SDGs) to empower them to join the movement to tackle the world's problems covered by the SDGs. The practical activities in this chapter aim at supporting us, teachers, in helping students to understand better SDG 9 and its targets, why they are important, how to involve students to take action right now and also to have a deeper engagement towards the achievement of the Global Goals for a sustainable world.

Children are driven by curiosity and playfulness.

The playfulness approach should be used at school for all learning to build effective and inclusive schools, and continued through a lifetime. According to Göncü, playfulness contributes mainly to:

- the development of problem-solving
- creativity
- perspective taking
- the development of language.

This approach, with experimentation and risk-taking, inventing and failing, and somehow succeeding, develops our ability to learn with skills that allow us to build sustainable cities, environments and societies. It also encourages, accepts and acknowledges not only the individual skills but also the exchanging and joining of ideas and experiences.

This chapter explores how teachers can offer activities and role-modelling, and support and value creative thinking, active engagement and critical-thinking skills for children to learn and use a language through play.

Across cultures and backgrounds, children are born with a natural urge to be playful, to take risks and to create their own worlds. Creativity in teaching supports this urge in children. However, while we may recognise that creativity should be one of the most important priorities in teaching, we unfortunately still lack an understanding of how to support it.

Creativity speaks to a child's natural urge to give form, or expression, to the products of their imagination, and it involves bringing inner feelings and ideas into being (Ackermann, 2004). Nonetheless, as children grow older, creativity appears to wane. Is it that we as teachers destroy or reject creativity leading to children rejecting unrewarded behaviour? Whatever the reason may be, it is important to develop, maintain, support and encourage creativity by using the playfulness approach throughout the learning process.

To do so, I use an adaptation from the Model of Culture (Gauntlett and Thomsen, 2013). This model is the Model of Creativity in the Playfulness Approach and uses four steps:

- Thinking – when there are stimulating environments and resources
- Playing – when there are many inspirational activities
- Making – when students can put into practice what they have thought and done while playing
- Sharing – when there is the engagement of all students and teachers, by exchanging ideas and meanings.

This model draws attention to aspects of a thriving creative English language classroom, and so can be used to organise and plan classes for developing, maintaining, supporting and encouraging creativity through play.

In addition, playfulness and creativity are essential in the classroom not only for learning but also to help students think of how they can develop a sustainable society prepared to accommodate the rapid changes associated with innovation, technology and globalisation.

## Activities

All the activities make use of the Model of Creativity in the Playfulness Approach (thinking, playing, making, sharing), having as their main theme SDG 9 and its targets, as well as other SDGs on a secondary level.

### Activity 1: Wind power in the industrialisation process

#### Aim

- To develop students' understanding of why it is important to create new types of clean energy in the industrialisation process that do not harm the environment if we are to achieve the Sustainable Development Goals, or Global Goals as they are also called
- To feel empowered to play a part in creating innovative ways of sustainable energy in the industrialisation process in the future
- To understand that how we choose to act can have a positive impact on the global community

## Language focus

- To study vocabulary related to the environment, cities, industries and different types of energy
- To generate and share ideas, listen and respond to the ideas of other students
- To compare and contrast differences when using dirty and clean energy in industries, and think of the consequences of their use

## SDG focus

- SDG 9: Industry, innovation and infrastructure – To help students understand that companies can promote sustainable development and not harm the environment in their industrialisation process
- On a secondary level, SDG 7: Affordable and clean energy (wind power as sustainable and clean energy) and SDG 17: Partnership for the Goals (students working together to generate and share important ideas, not only about their community but also for the world to achieve the Global Goals)

## Creative focus

- Through play, students will be able to imagine what it is like to harm the environment and kill animals and people, and create innovative and sustainable ways of infrastructure.

Level A1–A2

Age 7–12 years

Time Two classes of 60 minutes

## Preparation

- Collect the material needed to build a forest, a village and a factory:
  - o three cardboard boxes
  - o thin sponge sheet
  - o acrylic paint
  - o papier mâché
  - o dry sticks
  - o paper, colour pencils, drawing pins for the pinwheels.

## Procedure

- Start the lesson by telling your students they will build a forest, a village and a factory.
- Ask them to draw everything they can find in those places. Teach them the vocabulary needed.
  - o Build the forest, the village and the factory with your students. Throughout the process, reinforce the vocabulary taught previously.



- o Take a big square-shaped cardboard box and paste a layer of thin sponge sheet over it.
- o Paint a layer of brown acrylic on the sponge.
- o Using papier mâché, make a river with raised banks. Paint the river blue and the banks green after drying.
- o It is also possible to make rocks and stones using papier mâché too, and place them at certain points on the cardboard.
- o After the base frame is made, add trees and plants. You can use the papier mâché or dry twigs of real trees. Then fix all the trees at different locations on the cardboard.
- o Finally, make animals such as a lion, elephant, bear, owl, crane, crow, fox or any others you would like to teach them. Use papier mâché for the bodies and thick cardboard for the basic structures.
- o Repeat the same process for the village, adding a church, a school, a hospital, houses and other buildings you want to teach them, and the car factory, adding buildings and cars.
- o Allow the models to dry for at least two or three days.
- In the next class, show the students the models and ask them what they see. Revise vocabulary.
- Ask them if they know what factories need to build cars – materials and energy.
- Show them pictures of different types of dirty energy (the pictures can be easily found on the internet or in other resource books), such as hydropower, nuclear power, fossil fuels. Teach them the vocabulary.
- Tell them that if the factory uses hydropower, the village may not have clean water any more and everyone will suffer – we need to destroy our model of the village; if they use nuclear power, there may be leakage and everyone may suffer from it – we need to destroy our model of the village and forest; if they use fossil fuels, they will pollute the environment and cause many diseases – we need to destroy the model village and forest.
- Ask students if they want to destroy their models. Tell them it is the same with the environment – if we use dirty energy in the industrialisation process, our forests and villages, towns and cities will be harmed, and people and animals will suffer.
- Show them pictures of clean energy (the pictures can be easily found on the internet or in other

resource books), such as solar power and wind power. Tell them they come from nature and damage the environment much less.

- Make pinwheels representing windmills using paper, pencils and drawing pins



- Allow them to play together outside the classroom so that they can feel the wind moving the pinwheels, and explain that this power moves giant windmills in factories and generates clean energy for machines in the factories.



- Finally, tell them that factories must find ways of developing sustainable infrastructure (for instance, clean energy to power their machines) to support human well-being. Tell them this is one of the targets of the Global Goals and that everyone must work hard to achieve them by 2030. You can show a poster with all the Goals and show them the ones used in this activity. See: <http://www.globalgoals.org/#the-goals>.
- If it is difficult to find the material or if there is not enough time, it is possible to use other types of models, such as wood, plastic or paper. They can be easily made or even bought. If that is the case, only one class of 60 minutes is enough for this activity.

### Follow-up

- You can ask your students to write a short paragraph or a poem for homework saying what would happen if we allow factories to damage the environment and cities and/or what would happen if we support innovative and sustainable industrialisation processes. They can read these aloud in the following class and you can make a mural in your classroom with the stories and poems.

### Materials

#### Pinwheel model

- Cut along lines to centre circle.
- Sequentially fold outside dots to the inside dot.
- Attach to a pencil with a pin to form a pinwheel.

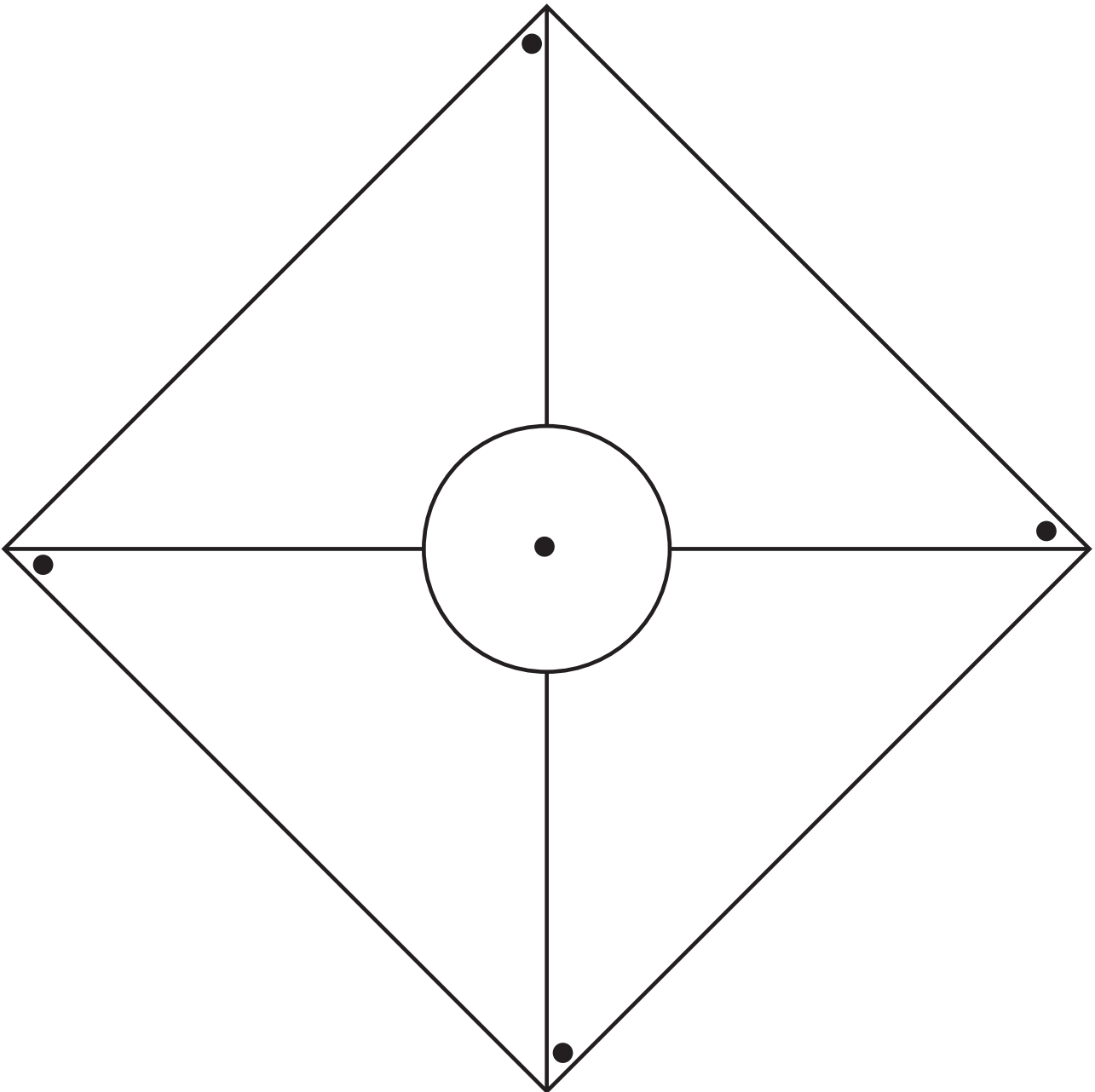

## Activity 2: Crayon factory

### Aim

- To develop students' understanding of a sustainable industrial infrastructure
- To critically evaluate our current industrial process and explore better ways of dealing with resources without producing waste
- To learn about the sustainable process of recycling and how it can support local economic development

### Language focus

- To learn vocabulary related to industries, waste and the recycling process
- To describe a process following steps
- To revise colours and their hues

### SDG focus

- SDG 9: Industry, innovation and infrastructure – To help students understand that it is important to develop a sustainable and resilient infrastructure to support economic development and human well-being
- On a secondary level, SDG 12: Responsible consumption and production (help students understand that we need to reduce the generation of waste through the three Rs: Reduce, Reuse and Recycle) and SDG 17: Partnership for the Goals (engage with organisations and individuals who have been working for many years on recycling materials by making use of a sustainable industrial process)

### Creative focus

- Through play, students will be able to understand what a sustainable industrial process is, how it is possible to reduce waste, and help the economic development by using a creative and innovative idea.

Level A1–A2

Age 7–12 years

Time Two classes of 60 minutes

### Preparation

- You will need to provide:
  - o paper or cardboard
  - o wax crayons of different colours
  - o plastic glasses
  - o small circle aluminium moulds
  - o black or white string.

### Procedure

- Start the lesson by explaining what a factory is. For example: 'A factory is a big building where workers gather together to make products. Each worker has a specific job and together they can make the process quickly. Factories were first invented back in the 13th century and they were very simple. Nowadays, we have a lot of different kinds of factories in the world.'
- Ask them if they know some kinds of factories, for example mining, quarrying, fishing, forestry, farming, car and recycling.
- Teach them vocabulary of the parts of the factory and its infrastructure, for example power house, power generator, machines, equipment and raw material.
- Ask them to draw the parts of the factory on paper or cardboard. Give them wax crayons to colour and let them play with the models, revising vocabulary.
- Ask them if they know how the industrial process works, from the raw material to the final products. Explain, if necessary.
- Ask them what to do with the crayons that are left. Tell them that if it is possible to reuse them, they should put them away; if not, reinforce the question.
- Explain that to build a factory with a sustainable infrastructure, we cannot have waste. Then tell them that together you will build a factory and recycle the crayon ends.
- In the following class, tell your students you will make a necklace with the crayon ends and ask them to sort them out by colour into the plastic glasses.
- Then ask each student to get an aluminium mould and put the crayon ends there. Each student may choose the colours they like the most. This is also an opportunity to revise colours and their hues.
- If you live in a hot country, leave the moulds in the sun for some time until the crayon ends melt and fuse. If not, melt them in a bain-marie pot, but do it yourself. Do not let your students near the heat.



- Let them dry, make a small hole in one side of the circle and pass the string through to make the necklace.
- Finally, tell your students that industries must find ways of developing sustainable infrastructure to reduce the generation of waste, recycle and support the economic development of that country. Tell them this is one of the targets of Global Goals and that everyone must work hard to achieve them by 2030. You can show a poster with all the goals and show them the ones used in this activity. See: <http://www.globalgoals.org/#the-goals>.

**Follow-up**

- You can take your students on a field trip to visit a recycling industry if there is one in your area. They can compare the industrial process to the one you studied in class and see if that factory is sustainable, if it is helping to reduce the generation of waste and if it is supporting the economic development of your area. Help them write a text about the trip.



### Activity 3: Internet string

#### Aim

- To develop students' understanding of how technological gadgets are interconnected and how they work with and without the internet
- To think creatively to make connections and share them with all
- To make students understand that developed countries should commit to supporting the achievement of the Global Goals in less developed countries

#### Language focus

- To teach vocabulary of technological gadgets and places in school
- Give reasons for their choices
- Write a letter proposing solutions to a problem

#### SDG focus

- SDG 9: Industry, innovation and infrastructure – To help students understand that it is important to ensure all have access to the internet and new technologies, especially those living in the least developed countries
- On a secondary level, SDG 4: Quality education (improve school facilities, better equipped with internet to provide a positive environment for all) and SDG 17: Partnership for the Goals (engage with organisations and individuals who have been working with communications)

#### Creative focus

- Through play, students will be able to understand how technological gadgets work, how it is important to have access to the internet for them to work and help suggest creative and innovative ideas to provide access to the internet to all.

Level A1–A2  
Age 7–12 years  
Time 60 minutes

#### Preparation

- You will need:
  - o one large ball of string
  - o one set of images of technological gadgets and school materials
  - o one set of images of places in your school.

#### Procedure

- Give each student one of the images of the technological gadgets and school materials and make a circle.
- Hand one student who is holding an image of a gadget the end of the ball of string and ask them to look around and see if there is an image of a place in school they would put it in or another gadget they think theirs should be connected to.
- When they have chosen one, ask them to explain why and then either take the string to the student holding that image or allow the student to throw it.  
Example: Picture of a computer can be placed in the classroom because the teacher can use it to deliver their class, or in the computer lab so that students can look up information or practise what they have learned.
- Tell the student who now has the string to look at the remaining images and decide how their image relates to a different one. Again, they explain why and the ball of string is taken or thrown to the students.  
Example: Picture of a classroom can be connected to a TV or an interactive whiteboard.
- Continue this activity until you have a spider's web across the circle and/or it becomes too difficult to make connections. The students have to think creatively as the activity progresses, but that is part of the challenge.
- Ask the student holding one of the images to pull on their string. When the other students find their string moving, explain that this is because everything is interconnected and needs to be so in order to work.
- Explain that the string represents the internet and that it is needed to make the technological gadgets work well and use their full potential in a school.
- Repeat the activity with two circles of students: one with the string and the other without it. Make them see that the one without the string will not make any connections, so the gadgets will not be connected and will not work.



- Tell them that in some countries and areas, there is no access to the internet and ask them to think how they could help.
- You can tell one student from the circle with string to throw it to the circle without string. In this way, they will understand that we need to provide this area with internet access.
- Tell them that one way to provide these areas with internet is by using satellites. It is the same as throwing the string to the circle without it.
- Finally, tell your students that we must find ways of providing the internet to all to ensure the spread of new technologies, including in schools, especially for those living in the least developed countries. Tell them this is one of the targets of the Global Goals and that everyone must work hard to achieve them by 2030. You can show a poster with all the goals and show them the ones we used in this activity. See: <http://www.globalgoals.org/#the-goals>.

### Follow-up

- You can teach your students how to write a letter to your local government or NASA to suggest the spreading of internet signals via satellite. Most letters are answered and students will feel empowered to think of other creative suggestions and put them into practice.



## Activity 4: Circular economy game

### Aim

- To help students understand what a circular economy is: one that is restorative and regenerative, and aims to keep products, components and materials at their highest utility and value
- To compare and contrast linear and circular economies, and help students understand why the latter is the best model
- To help students understand it is important to provide small businesses with access to technical support, for their development and the country's

### Language focus

- To teach vocabulary of means of transportation on the sea, in the air and on land
- To help students obtain oral language proficiency with storytelling
- To learn basic vocabulary related to economy (linear: take, make, waste: circular: reuse, recycle, cascade)

### SDG focus

- SDG 9: Industry, innovation and infrastructure – To help students understand that governments need to provide small businesses with access to technical support for their development
- On a secondary level, SDG 11: Sustainable cities and communities (provide access to safe, affordable, accessible and sustainable transport systems for all) and SDG 12: Responsible production and consumption (substantially reduce waste generation through prevention, reduction, recycling and reusing).

### Creative focus

- Through play, students will explore the importance of seeing the whole system in order to design solutions. By critically evaluating the challenges, they will understand that it is possible to build a restorative economy using creativity and innovation.

Level A1–A2

Age 7–12 years

Time Two classes of 60 minutes

## Preparation

- You will need to collect:
  - o models of a boat, a plane and a car
  - o pencils and felt tips
  - o glue
  - o scissors
  - o paper clips
  - o tape.

## Procedure

- Tell your students you will make a trip by sea, by air or by land and you must reach your destination. Ask them what kind of transport you need – a boat, an aeroplane and a car.
- Prepare fewer models and materials than the number of students. For example, if you have ten students in class, provide them with three models and materials for the boat, three models and materials for the aeroplane, and four models and materials for the car.
- Give them the material and models. Ask each one of them to make one boat, one aeroplane and one car. They will see that the models and materials they have are not enough.
- Let them do what they can and play with their toys.
- Before the end of the class, ask each one how they would manage without all the transport for their trip. Help them understand that not all of them would reach their destination.
- At the end of the class, put all the toys in a plastic bag and tell them you will throw them away, but keep the bag with the toys.
- Explain that this model of building things is the one most factories use and it is called linear economy based on the take-make-waste system.
- In the following class, bring the toys and tell them that instead of throwing the toys away, you can reuse the materials to make them all reach their destination.



- Help them understand that you can use the materials and design fewer boats, aeroplanes and cars, and that they can share the transport. Let them play together with the new models and tell the story of how they reached their destination.
- Finally, explain that this is called circular economy, and not all factories use this model but the big ones do. Tell them everyone needs to help small companies to have access to technical support to build competencies in circular design to facilitate product reuse, recycling and cascading. Tell them this is one of the targets of the Global Goals and that everyone must work hard to achieve them by 2030. You can show a poster with all the goals and show them the ones used in this activity. See: <http://www.globalgoals.org/#the-goals>.

### Follow-up

- You can record students telling their stories about how they reached their destination together. Alternatively, for older students, you can ask them to write the story.

### Additional resources

This activity was based on the concept of circular economy explained by the Ellen MacArthur Foundation. The website provides explanations and case studies that can be the base for further ideas of other creative activities: <https://www.ellenmacarthurfoundation.org/circular-economy/overview/concept>.





**Materials**

**Boat model**

- Start from a rectangle. Fold in half (1).
- Fold in half and unfold (2).
- Fold to the centre (3).
- Fold the overlapping strip upwards (4).
- Fold corners backwards. Turn over (5).
- Fold strip upwards (6).
- Open (7).
- Opening in progress (8).
- Fold triangle upwards. Repeat behind (9).
- Open – similar to steps 7 and 8 (10).
- Take upper corners and stretch out (11).
- Finished boat. Colour as you wish (12).

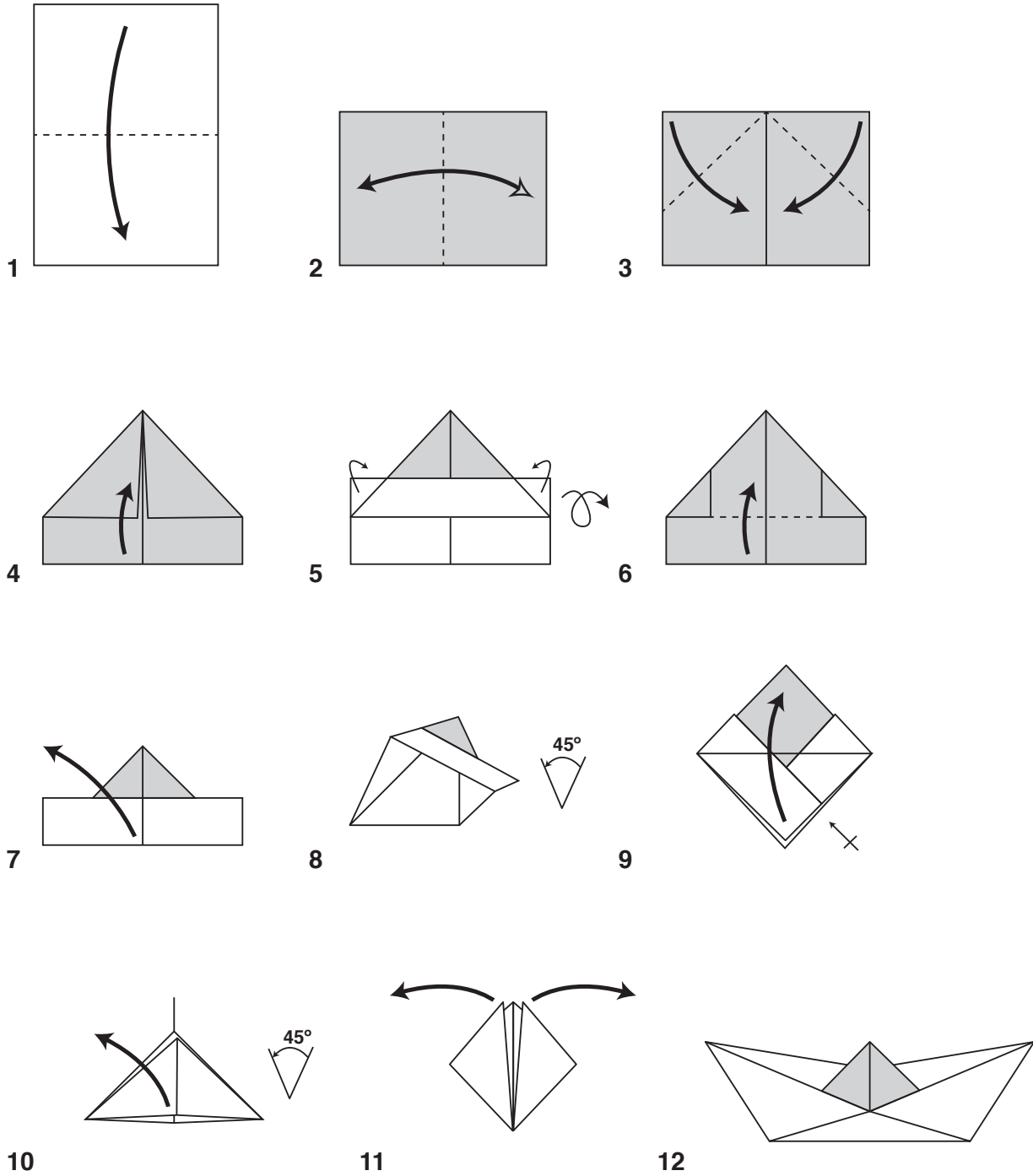

### Aeroplane model

- Fold the paper in half vertically. Unfold (1).
- Fold the left and right corners in to meet the centre crease (2).
- Fold the left and right corners in to meet the centre crease once more (3–4).
- Valley fold the paper in half (5–6).
- To form the first wing of the paper aeroplane, fold the open side down so that it touches the folded centre, leaving a 1 1/2 inch space at the nose of the plane. Flip the plane over and repeat. Make sure the wings are symmetrical so that the plane flies properly (7–8).
- Finished plane (9). It is possible to use paper clips or tape added to the wing of the plane to make it fly better. The extra weight makes the plane more aerodynamic.

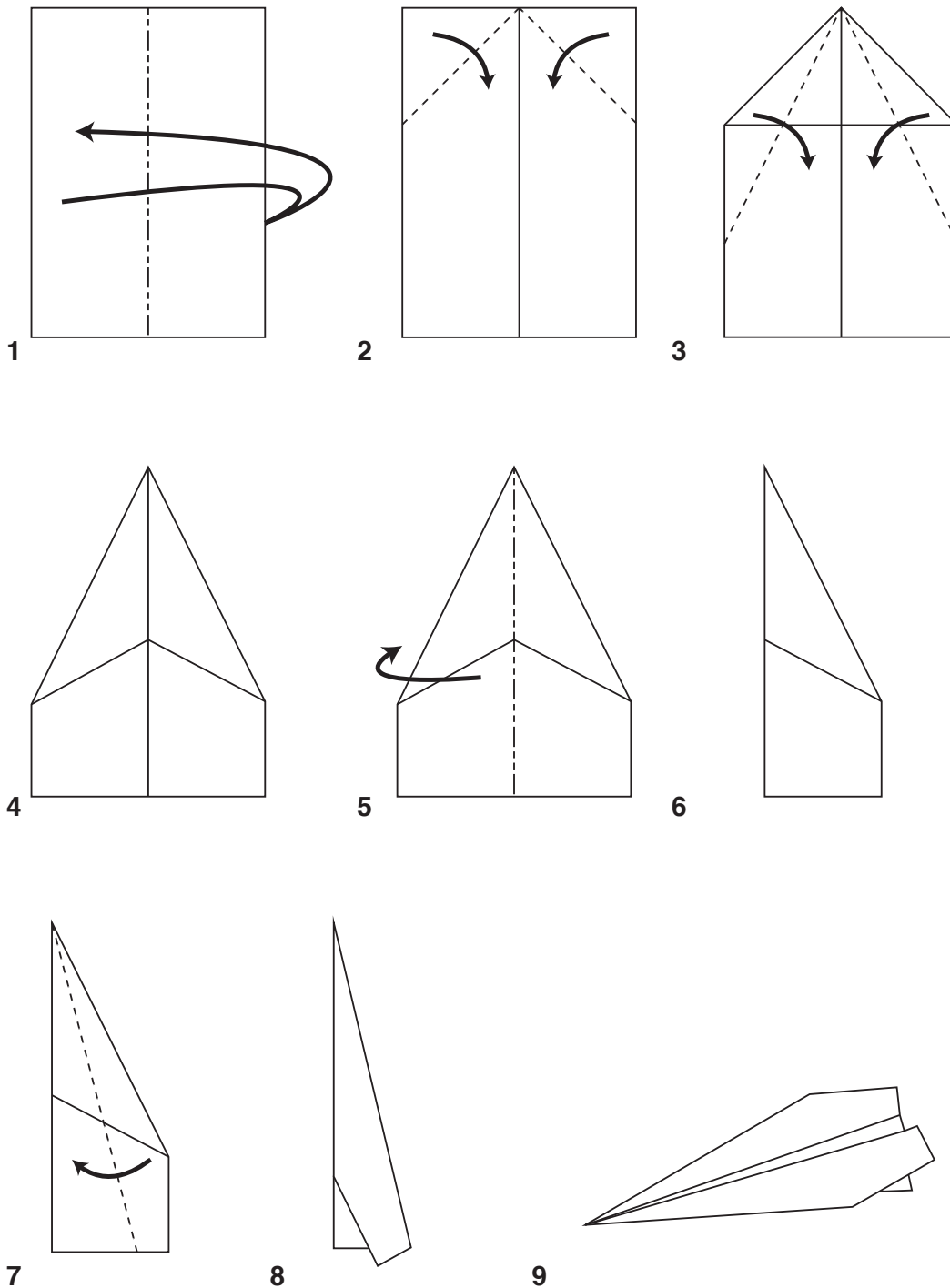

L

### Car model

- Fold in half to make a crease and fold back (1).
- Fold in the dotted lines (2).
- Fold in the dotted lines (3).
- Fold in the dotted lines (4).
- Fold in half (5).
- Pocket fold in the dotted lines (6).
- Cut with a pair of scissors and tuck in (7).
- Draw windows and finish the car (8).

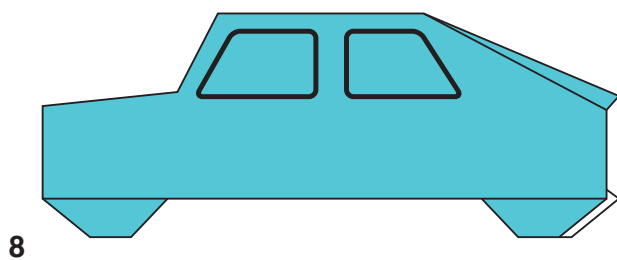
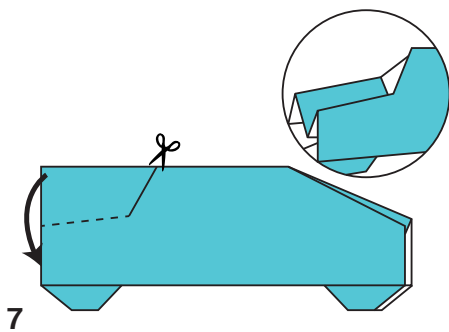
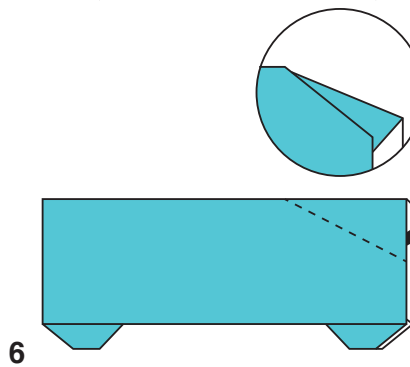
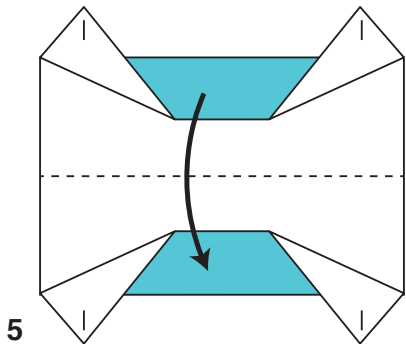
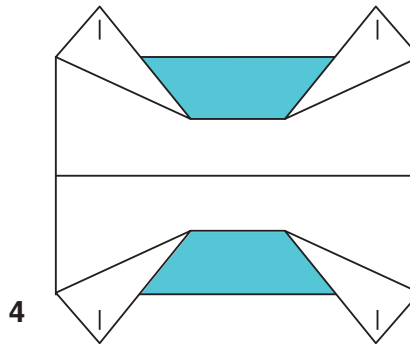
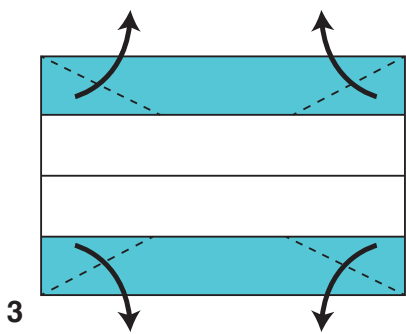
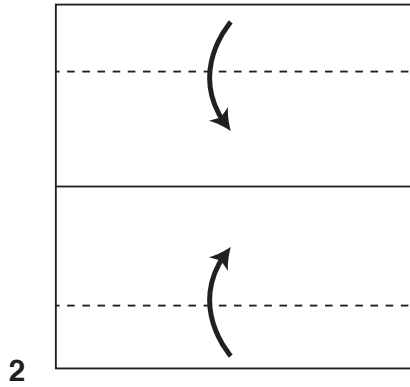
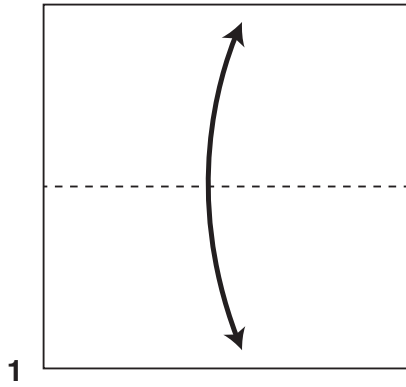

## Further resources

All the activities presented in this chapter support and value creative thinking, active engagement and critical skills to learn a language through play, but also to learn creative, innovative and sustainable skills that will be important for students when they are ready to work in companies and as entrepreneurs. These further resources present additional materials and lesson plans based on these skills and on the Global Goals.

- British Council Voices – How to teach the UN's development goals, and why: <https://www.britishcouncil.org/voices-magazine/why-teach-uns-development-goals-and-how>. Emily Reynolds explains why it is important to teach our students about the UN Global Goals and how we can teach them.
- Practical Action – Global Goals: <http://practicalaction.org/global-goals> This website has a range of different activities to support teachers in helping students understand the Global Goals and how they can take action themselves to help achieve them.
- Teach Unicef – Sustainable Development Goals: <https://teachunicef.org/teaching-materials/topic/sustainable-development-goals>. This website has a collection of teacher resources that educate students on the SDGs and empower them to join the movement.
- Think Global – Suggested reading: <https://think-global.org.uk/library/suggested-reading/>. This is a very useful website about global learning. This page includes resources to read the subject more in depth.
- World's Largest Lesson – 9 Industry, innovation and infrastructure: <http://worldslargestlesson.globalgoals.org/global-goals/innovation-and-infrastructure/>. An excellent website with good resources to teach young people about the Global Goals and encourage them to become the generation that will change the world. This page is focused on SDG 9 and contains full lesson plans.

## Bibliography

- Ackermann, E (2004) The whole child development guide. Billund: LEGO Learning Institute. Available at: [www.legofoundation.com](http://www.legofoundation.com).
- Brown, T (2009) Change by design: How design thinking transforms organizations and inspires innovation. New York: Harper Business.
- Epley, N and Caruso, EM (2008) 'Misstepping into others' shoes', in KD Markman, WMP Klein and JA Suhr (eds), Handbook of Imagination and Mental Simulation. Hove: Psychology Press.
- Gauntlett, D (2015) 'The LEGO System as a tool for thinking, creativity, and changing the world', in Making Media Studies: The Creativity Turn in Media and Communications Studies. New York: Peter Lang. Available at: <http://davidgauntlett.com/complete-list-of-publications/>.
- Göncü, A (2013) Sociocultural and creative processes in imaginative play for young children. Billund: The LEGO Foundation. Available at: [www.legofoundation.com](http://www.legofoundation.com).
- Johnson, S (2010) Where good ideas come from. The natural history of innovation. New York: Riverhead Books.
- Nidumolu, R, Prahalad, CK and Rangaswami, MR (2009) 'Why Sustainability Is Now the Key Driver of Innovation', in Harvard Business Review. Watertown: Harvard Business Publishing.
- United Nations Sustainable Development Knowledge Platform: <https://sustainabledevelopment.un.org/sdgs>

# 11

## Sustainable Development Goal 10: Reduce inequality within and among countries

Alan Maley

### Introduction

SDG 10 emphasises the need to reduce inequality between countries. But the issue of inequality goes well beyond this. In many ways it is one of the central issues of all the SDGs because inequality between people, societies and countries affects almost everything else. Some people have obscenely inflated salaries, others earn next to nothing; some people own more than one luxury residence and lots of land, others live in shanty towns or sleep rough on the city streets and own nothing; some people take a constant supply of clean water for granted, for others finding water fit to drink is a daily challenge; some people have access to state-of-the-art medical care, others cannot afford even basic medicine or vaccinations; some people eat nutritious food and drink far too much, others are close to starving; some babies live to adulthood, others die before they can walk; some people have access to superb educational facilities, others remain illiterate; in some societies girls are regarded as family property under male dominance, in others they have access to the same privileges as males (or almost!); some people belong to self-sustaining elites of one kind or another (social, educational, ethnic, linguistic, ...), others remain segregated from privilege; some people are free to move and choose their way of life, others are confined to refugee camps. So there is considerable overlap between the many types of inequality. What is certain is that inequality not only causes immense personal suffering and deprivation, it also spills over into conflict, division and underdevelopment, which affect the lives of everyone.

Clearly, as teachers of language, we cannot expect to radically change the unequal way the world is currently organised. But many small drops can help fill a bucket, so even our more modest efforts can and will make a difference. There are innumerable instances of change taking place in seemingly hopeless circumstances: Gandhi's campaign for Indian independence from Britain, the campaign for women's votes in the UK, the abolition of slavery in the UK, the release of Nelson Mandela and the end of apartheid, the long struggle of Aung San Suu Kyi to restore democracy in Myanmar. Our main aim here,

then, as educators as well as language teachers, is to raise awareness of the issues around inequality and ignite a wish among our students to change things. In this chapter I hope to show how this aim can be achieved through activities which involve effective language learning through creative participation.

As I have indicated, there are many varieties of inequality, so it would be impracticable to try to attend to them all. The following activities start with a general overview of inequality, then focus on socio-economic and personal freedom issues. Other inequality issues are referenced in the Further resources section at the end of the chapter.

Although we live increasingly in an electronically connected age, and in many places can assume that our students have ready access to the internet and to smartphones, this is not universally the case. In fact, one form of educational inequality is inequality of access to the internet. So, while I shall often suggest activities which involve the use of web-links and smartphones, I shall also suggest less technologically sophisticated approaches. Moreover, in terms of classroom management, there will be times when students will need to activate their brains before they access their phones. Technology should be a means of enhancing creativity, not replacing it.

### Activity 1: What is inequality?

#### Aim

- To stimulate students to think about and discuss some of the many forms of inequality in general and in their own contexts.

#### Language focus

- Expressions of opinion (I think, I believe, It seems to me, It's obvious that ..., etc.)
- Revision and consolidation of question forms, especially: What? Why? How? Who? When? Where?

#### SDG focus

- SDG 10 – Showing the varied and widespread nature of inequality

## Creative focus

- Participation in the performance of a text

Level B1–B2+  
Age 14+  
Time 20 minutes

## Preparation

- Make sure you have enough photocopies of the worksheets.

## Procedure:

- Write the word 'fair' on the board. Ask students to think about what it means for them. (No dictionaries or smartphones.) Record their ideas on the board.
- Now ask them to look up the word 'fair' in their dictionaries or on their phones to find synonyms: morally right, just, unbiased, treating all equally, reasonable, as it should be, etc.
- Focus on common collocations of 'fair': fair trade, fair shares for all, fair play, it's not fair, etc.
- Ask students to write one definition for each of them to show its meaning, e.g. Fair trade means ensuring that producers in overseas countries get a good price for their work.
- Ask students where they get the news (global and local) from: newspapers, radio or TV news, online news items, other people (gossip). Use Worksheet 1. Discuss the results with them.
- Show these pictures (if possible) of a luxury mansion and a favela (slum) in Brazil.



- Ask the students to work in pairs to discuss the pictures in terms of the word 'fair'.
- In groups of four, ask students to make a list of other forms of unfairness they know about or have experienced. Remind them of ways of expressing an opinion and encourage them to ask as many questions as possible.
- When they have listed about five items, share ideas with the class. Then ask them to rank their items from most important to least important.
- In groups of five or six, students prepare to perform the poem 'The Luck of the Draw' from Worksheet 2.
- The aim is to involve everyone in the performance and to make it as original and interesting as possible to watch and listen to. They can do this by varying the number of speakers, varying volume, pitch and speed, by adding gestures or movement. Allow 15 minutes' preparation time.
- Groups perform the poem to their classmates. If possible, ask students to use a video camera or smartphones to record the performances.

## Follow-up

As homework, students write a paragraph (or a short poem or story) about something unfair that has happened to them.

Over the coming weeks, students search for news items about various forms of inequality and record these for discussion in a later class.

## Materials

### Worksheet 1: Where do you get your news from?

1. Newspapers
2. TV or radio news broadcasts
3. Online news items
4. Other people

Put these in order of frequency. For each item, put a number from 1 to 5 (1 = every day, 5 = never).

## Worksheet 2: The Luck of the Draw

It's the luck of the draw,  
just the luck of the draw –  
it's nothing to blame yourself for –  
It's the luck of the draw.

So if I've got pots of money  
and you are dirt poor,  
don't blame me, dear boy.  
It's just the luck of the draw.

And if I live to 100  
and you die at 34,  
there's nothing to be done.  
It's just the luck of the draw.

So, if you get less and less,  
and I get more and more,  
that's the way things are, old chap.  
It's the luck of the draw.

And if you work 15 hours a day  
and I can sleep for 24,  
don't let it worry you.  
It's the luck of the draw.

And if you eat corn soup  
while I eat caviar,  
why should I care?  
It's the luck of the draw.

And if I live in a mansion,  
and you sleep on the floor,  
I know it's not fair but  
it's just the luck of the draw

And if you end up in prison,  
while I manipulate the law,  
why moan about it, my friend?  
It's just the luck of the draw.

And if you don't like it,  
if it sticks in your craw,  
my advice to you, old chap,  
is simply to ignore  
it, and move on, don't feel sore.  
After all, it's the luck of the draw.  
Just the luck of the draw.

*By Alan Maley*

## Additional resources

UN Goal 10: Reduce inequality within and among countries

- Facts and figures / stories and articles / links – teachers would have to adapt this information to build a lesson plan: <http://www.un.org/sustainabledevelopment/inequality/>

Fair Trade International

- Students can read more about what fair trade is. Also, in the session 'Fair Trade Near You', they can check if there are producers or products near where they live. As a follow-up activity, they can have a field trip to know the producers and ask them questions or buy products (practice of question forms/opinions): <http://www.fairtrade.net/>

World Economic Forum

- This website shows five reasons why we need more equality and suggests six ways to reduce inequality through economic democracy: <https://www.weforum.org/agenda/2015/09/5-reasons-why-we-need-to-reduce-global-inequality/>

## Activity 2: Inequalities in wealth

### Aim

- To make students aware of the gross discrepancies between very rich and very poor people.
- To help them think about money in relation to value and how unfair wages contribute to decline in public services.

### Language focus

- Comparative adjectives: more, less, better off/worse off, more/less important, etc.
- Vocabulary associated with jobs/professions: doctor, shop assistant, etc.
- Giving reasons for an opinion: because ..., it's obvious that ..., all the evidence shows ..., etc.
- Second conditional: if they were not ...

### SDG focus

- SDG 10 – Focusing on excessively unfair distribution of income and wealth

### Creative focus

- Writing a poem

Level	B2 upward
Age	14+
Time	120 minutes

## Preparation

- Make sure you have enough photocopies of the worksheets.
- Check on some of the basic statistics – average earnings of professions, of celebrities. See:
  - o <http://www.worldsalaries.org/>
  - o <http://www.reed.co.uk/average-salary>
  - o <http://www.mywage.org/zimbabwe/main/salary/vip-celebrities-pay/celebrity-actors-pay>

## Procedure

- Ask students to make a list of jobs/professions they think are most valuable to society. Allow about five minutes for this.
- Students now work in groups of four. They share their individual lists and produce a composite list.
- Now ask them to exchange their list with another group. Groups now rank the items on their new list of jobs in order of importance, using Worksheet 1.
- In a whole-class report-back session, try to elicit the salaries of the most highly ranked jobs/professions/occupations in your society.
  - o How much does a nurse earn?
  - o A teacher?
  - o A police officer?
  - o A train driver?
  - o A fireman?
  - o An ambulance driver?
  - o A doctor?
  - o etc.
- Note the figures down on the board. If the information is not available from memory, allow students to look for it on their smartphones or tablets, or supply it yourself.
- Now elicit the names of some famous celebrities – sportspeople, film stars, pop singers, businessmen, etc. – and write them on the board. You can either elicit these or have a prepared list ready.
- Ask students to guess how much these people earn. Write up the figures against the names on the board. Ask students to check the figures using their smartphones. See Additional resources below.

- Conduct a class discussion. Use some leading questions:
  - o Is anyone really worth that much money?
  - o Why do we reward people like this when more essential workers are paid so little?
  - o How much is 'enough'?
  - o What could be done to make what people earn match with their value to society?
  - o etc.
- In preparation for writing a poem, ask students to refer to their rankings lists. They should choose five highly ranked occupations from the list, e.g. nurse, garbage collector, postman/woman, midwife, fireman, train driver, etc.
- Ask them to think what would happen if these people were not there to provide these essential services. Let them write down some ideas using the second conditional: e.g. 'If we did not have train drivers, ...'
- Ask them to use the template in Worksheet 2 to write a poem about the five occupations they have chosen.
- Make sure the poems are displayed where everyone can read them.

## Follow-up

- Ask students to complete Worksheet 3 as homework and bring it to class next time.
- Students make a visual poster to highlight the different forms of economic inequality, using their own photographs or those they have found on websites. They should find an eye-catching caption, e.g. Some people are more equal than others.



## Materials

### Worksheet 1: Professions

Name of job/profession	Ranking in importance 1 = least, 5 = most

### Worksheet 2: Poem template

Poem template: Complete the lines, using the five occupations you have chosen. There is no need to make the lines rhyme.

Nurses only earn ... a week,  
Yet if they were not there,

---

Postmen only get ... a week,  
Yet if they were not there,

---

Midwives only earn .... a week,  
Yet if they were not there,

---

etc.

José Mourinho earns ... a week.  
Would we miss him  
If he was not there?  
Would it matter?

### Worksheet 3: A poem

The lines of this poem are in the wrong order. Rearrange them in the order you think makes the best sense. Compare your version with a partner. Read your versions aloud to each other.

His life is hard and full of toil.  
He sees the sacks of rice he's grown  
The owner makes him work the field  
The peasant farmer ploughs the soil.  
And never have enough to eat.  
The owner acts just like a king  
His children walk on bare feet  
On land that he will never own.  
But is there anyone to care?  
Forces him to increase the yield.  
And doesn't care for anything.  
Such inequalities are everywhere

*Mei Ya Liang*

## Additional resources

Wikipedia – Distribution of wealth

- This shows the discrepancy between the richest and poorest people in the world: [http://infographic.statista.com/normal/chartoftheday\\_4249\\_the\\_62\\_richest\\_people\\_are\\_as\\_wealthy\\_as\\_half\\_the\\_world\\_n.jpg](http://infographic.statista.com/normal/chartoftheday_4249_the_62_richest_people_are_as_wealthy_as_half_the_world_n.jpg)

OECD – Organisation for Economic Co-operation and Development

- There is some key information on income inequality and poverty. There is also a tool called 'Compare your income'. Students can use the salaries/income of footballers, movie stars, etc. They answer some questions and at the end they compare their answers with reality (what you think / your ideal / in reality): <http://www.oecd.org/social/inequality-and-poverty.htm>

Enough by John Naish (2009) London: Hodder paperbacks.

- It is full of good material to critique contemporary society, which has lost the concept of 'enough' and seeks to acquire too much.

## Activity 3: Personal freedom

### Aim

- To show that slavery and human trafficking is still widely prevalent in the 21st century and to engage students with ideas of the human right to personal freedom of choice

### Language focus

- Expressions of surprise/shock: I'm amazed that ..., I can't believe ..., How is it possible that ...?, It's shocking that ..., etc.
- Expressions of intent: I would (do) ..., We should try to ...
- Vocabulary related to freedom and the lack of it: slave, forced, compelled, not allowed to ..., victims, trapped, etc.

### SDG focus

- SDG 10 – Related to slavery and human trafficking

### Creative focus

- Participation in the performance of a text and writing a poem based on the text

Level B2+

Age 14+

Time 120 minutes

## Preparation

- Make sure you have enough photocopies of the worksheets.

## Procedure

- Write the words 'slave' and 'slavery' on the board. Ask students to write down any words which immediately come to mind in association with these two words. They then compare their words in pairs.
- Ask students which countries they associate with slavery. They can discuss this in pairs.
- Conduct a class discussion using their ideas from the above. If necessary, give question prompts:
  - o Are there different kinds of slavery?
  - o What does it mean to be a slave?
  - o Does slavery still exist? If so, where?
  - o Is there any slavery in our country?
  - o Why do people make others into slaves?
- Generally, students tend to associate slavery with the past, and with the slave trade from Africa to America and the West Indies in the 18th and 19th centuries. They are usually surprised that slavery is still widespread, even in countries like the UK. On the board write a few statistics (see Additional resources) – the number of slaves:
  - o worldwide
  - o in London
  - o in your own country.
- Conduct a class discussion about these.
- Students work in groups of four or five. Distribute copies of Worksheet 1 to each group. Tell them they have 15 minutes to prepare a dramatised reading of the text. The aim is to involve everyone in the performance and to make it as original and interesting as possible to watch and listen to. They can do this by varying the number of speakers, varying volume, pitch and speed, by adding gestures or movement.
- Each group then performs the text. Make video recordings if possible.
- Students work individually, using the text in Worksheet 1. Ask them to read the text carefully again. They should note down or underline between six and ten words or phrases that make an impression on them, or that they feel are especially important.

- Allow 10–15 minutes for them to use these words and phrases in a short poem. They can give a title to the poem.
- If time allows, ask them to share their poems with others in the class. Then make sure they are displayed somewhere. The aim is to involve everyone in the performance and to make it as original and interesting as possible to watch and listen to. They can do this by varying the number of speakers, varying volume, pitch and speed, by adding gestures or movement.

### Follow-up

- Set students a project on human trafficking. They will need to consult web links (see below), books and articles. The aim of the project is to write a short report and/or a visual display to show what human trafficking is, how it works, what results from it and ways of eliminating it from the world.
- If it is appropriate in your teaching context, encourage students, individually or as a group, to become active with one of the several NGOs working to eradicate slavery. See below.

## Materials

### Worksheet 1: I am a slave

Prepare a performance of this text. Your teacher will give you instructions and help.

My name is Ayesha. I am 14 years old. I live in London. I am a slave.

How do I know that? Well, I work every day. Sometimes I work for 14 hours a day. But they do not pay me.

How do I know that? Well, I cannot leave this house. They lock all the doors and I do not have a key. If I go out, they go with me. And I have no papers – no passport, no work permit – nothing. So I cannot run away. I am a prisoner. They always tell me, 'If you run away, the police will catch you. They will put you in prison.'

How do I know that? Well, I sleep on the floor in the room where the washing machine is. I sleep on a mat on the floor with an old blanket to cover me. I have to wash there too. I am not allowed to use their bathrooms. And I cannot use the washing machine for my clothes. I have to wash them in the sink – in cold water.

How do I know that? Well, there is a toilet outside the back door. That is the one I use. They have four bathrooms in the house. I clean them every day but I am not allowed to use them.

How do I know this? Well, I only have the shirt and jeans I was wearing when I arrived here. And my old sandals. They gave me one old tee-shirt, two pairs of pants, a short dress and a pair of old trainers. Oh, and a towel to dry myself with. That's all I have. And I cannot buy new clothes because I have no money.

How do I know that? Well, all I get to eat is what they leave. Sometimes there is some rice or bread. Sometimes there is a bit of fish or some chicken bones. Sometimes there are some cold vegetables. I drink water from the tap.

If I am not a slave, then what am I?

*(From unpublished novel:  
I am a Slave © Alan Maley)*

## Additional resources

### Modern slavery in Britain

- A very informative article on the slave trade in contemporary Britain: <http://www.telegraph.co.uk/sponsored/lifestyle/modern-slavery-britain/>

### Walk Free

- The website of Walk Free, one of the leading NGOs combating the contemporary slave trade: <https://www.walkfree.org>

### This Is What Slavery Looks Like in the 21st Century

- This site gives statistics: Distribution of Modern Slavery by Country in 2014: <https://mic.com/articles/104458/this-is-what-slavery-looks-like-in-the-21st-century>

### The Slavery of the 21st Century

- This website provides a bibliography of online articles on human trafficking at the end of the article: <http://www.coha.org/the-slavery-of-the-21st-century/>

### Anti-slavery

- This site defines the kinds of modern slavery, gives information on campaigns and what you can do to help: [http://www.antislavery.org/english/slavery\\_today/default.aspx](http://www.antislavery.org/english/slavery_today/default.aspx)

### Contemporary slavery

- This Wikipedia entry gives plenty of up-to-date information: [https://en.wikipedia.org/wiki/Contemporary\\_slavery](https://en.wikipedia.org/wiki/Contemporary_slavery)

### International Labour Organization

- This site provides facts and figures about child labour: <http://www.ilo.org/global/topics/child-labour/lang--en/index.htm>

### Child Labour Facts

- The facts about child labour show that it is a far-reaching problem, especially for children living in poverty around the world: <http://www.compassion.com/poverty/child-labor-quick-facts.htm>

## Resource bank

### Campaign information and events

<http://www.globalmarch.org/issues/Child-Labour>

### People Trafficking: United Nations facts, figures, campaigns

<https://www.unodc.org/unodc/en/human-trafficking/what-is-human-trafficking.html>

### People trafficking: Facts and campaigns

<https://polarisproject.org/human-trafficking>

### Information about endangered tribes in the Amazon basin

<http://www.survivalinternational.org/about/amazontribes>

### Article: gender and caste discrimination in India

<http://www.redressonline.com/2014/03/gender-and-caste-discrimination-in-india/>

### Horizontal Inequality and Communal Violence: Evidence from Indonesian Districts

<https://assets.publishing.service.gov.uk/media/57a08c6ded915d3cfd0013aa/wp22.pdf>

### Refugee inequality

<http://www.unhcr.org/refugees.html>

### Why today's migration crisis is an issue of global economic inequality

<https://www.fordfoundation.org/ideas/equals-change-blog/posts/why-today-s-migration-crisis-is-an-issue-of-global-economic-inequality/>

### Article: Facing the Health Challenges of the Global Refugee Crisis

<https://www.chathamhouse.org/expert/comment/facing-health-challenges-global-refugee-crisis#>

### Educational inequality

<https://s3.amazonaws.com/visualnews-wp-media-prod/wp-content/uploads/2016/06/08131626/Education-Infographics-21.png>

### World Inequality Database on Education – Here it is possible to explore disparities in education across and within countries.

<http://www.education-inequalities.org/>

A leadership development programme to help fight education inequality  
<https://www.teachfirst.org.uk/why-we-exist/what-educational-inequality>

The patient per doctor map of the world  
<http://bigthink.com/strange-maps/185-the-patients-per-doctor-map-of-the-world>

Why research infectious diseases of poverty? (ebook)  
[http://www.who.int/tdr/capacity/global\\_report/2012/chapitre1\\_web.pdf?ua=1](http://www.who.int/tdr/capacity/global_report/2012/chapitre1_web.pdf?ua=1)

Diseases and the links to poverty – article with facts and links  
<https://en.reset.org/knowledge/diseases-and-links-poverty>

Ready-made classroom materials for schools  
<http://www.wateraid.org/uk/get-involved/schools>

WaterAid – NGO  
<http://www.wateraid.org/>

Water issues: problems and solutions / unequal access / new threats to global water supply / water information and resources – useful links  
<http://globalwaterdances.org/the-event/water-issues/>

How people cope with unequal access to resources – Lesson plan with a list of useful websites  
[http://www.allthingsplc.info/files/uploads/grade6\\_socialstudies\\_howdopeoplecopewithunequalaccesstoresources.pdf](http://www.allthingsplc.info/files/uploads/grade6_socialstudies_howdopeoplecopewithunequalaccesstoresources.pdf)

Access to water and sanitation: disparities between the Earth's regions  
<http://www.emag.suez-environnement.com/en/access-drinking-water-sanitation-fundamental-universal-human-right-7437>

The Hunger Project: Facts about hunger and poverty  
<http://www.thp.org/knowledge-center/know-your-world-facts-about-hunger-poverty/>

The Big Thirst: Presentation – facts  
<https://prezi.com/i7zkgip14zbb/the-big-thirst/>

A Thirst for Equality – article with statistics  
<http://www.dukechronicle.com/article/2016/12/a-thirst-for-equality>

## Some lesson ideas

Five full lesson plans and materials on languages and other subjects, but that can be easily adapted to language learning/teaching. There are also some printables to use in the classroom to raise awareness of and support SDG 10.

<http://worldslargestlesson.globalgoals.org/global-goals/reduced-inequalities/>

Stories – Lesson plans from Nick Bilbrough's 'Hands Up' project  
<http://www.britishcouncil.ps/en/programmes/education/stories>

More or less equal? Resources for English – Several lessons plans to use with 11- to 16-year-olds exploring young lives in an unequal world  
<http://www.oxfam.org.uk/education/resources/more-or-less-equal-english>

There are some teaching ideas for exploring SDGs 10 and 17 and a lesson plan (education can transform the world)  
<https://globaldimension.org.uk/wllgoal/reduced-inequalities/>

Ideas for implementing practical ideas to transform education  
<http://practicalaction.org/schools>

**Acknowledgement:** I am most grateful to Malu Sciamarelli for her help with the photographs and in researching resources.



# 12

## Sustainable Development Goal 11: Make cities and human settlements inclusive, safe, resilient and sustainable

David Brennan

### Introduction

Goal 11 of the UN's Sustainable Development Goals (SDGs) is to make human settlements inclusive, safe, resilient and sustainable. Currently half of humanity – 3.5 billion people – live in cities. By 2030, almost 60 per cent of the world's population will live in urban areas. The world's cities occupy just 3 per cent of the Earth's land, but account for 60–80 per cent of energy consumption and 75 per cent of carbon emissions. The UN's SDG 11 programme has outlined a list of goals achievable by 2030, such as: upgrading slums and providing adequate, safe and affordable housing to all; providing safe affordable and sustainable transport for all, with specific focus on those with disabilities; improving road safety; increasing green areas and reducing the adverse per capita environmental impact of cities, with specific focus on air quality and waste management.

Cities are hubs for ideas, commerce, culture, science, productivity, social development and much more. At their best, cities have enabled people to advance socially and economically. It is self-evident how important this goal is to us and even more so to the next generation. We all live somewhere and we are all responsible to some extent for how we live and what we can do to make things better. In this respect, the topic of sustainable living should be of immediate importance and interest to all students. By engaging their creative potential, these lessons will harness the students' interest and bring greater awareness of these issues.

The overall goal for these activities is to help students engage with the issues of sustainable development (SGD 11); to develop and increase language awareness and student autonomy; to promote interaction with technology as a source and means of learning; and to draw on their creative potential to achieve these aims. Students themselves will be encouraged to create their own materials for the final tasks in this chapter. Most of the materials will come from online multimedia sources, making this activity almost paperless, if that is something you wish to do. Students will be given

examples and guided to materials related to Goal 11 and then encouraged to seek out similar materials.

In groups students will be asked to complete the following task (you can adapt this to suit your teaching context):

- Make and show a 15-minute video with the intention of promoting sustainable development.
- The video must include a poem (I have chosen a poem – you could choose another creative form such as a short drama, a speech, a dialogue, dance, mime or a combination of any of these).
- Each member of the group must participate in the video.

This is the end goal – all the other activities in the lessons should build up and be connected to this. Your job is to introduce the topic (SDG 11), stimulate the language associated with the topic, engage students with examples of sustainability/environmental- themed poems, encourage them to find more examples and come up with their own ideas and finally to organise them to present their video as a whole-class activity.

Maley (1997), Burton (2010), Cheon (2012), Cook (2001) and Tan Bee Tin (2013) have all shown that engagement in creative activities increases intrinsic motivation and language acquisition. Playful and creative aspects of language are more densely distributed through so-called authentic materials, which recent studies have shown to have a positive influence on second language acquisition (Gilmore, 2007; Mishan, 2005; Tomlinson, 2003).

### Activity 1: Problem cities

#### Aim

- To introduce the topic of sustainable development, to raise awareness of the issues and to introduce vocabulary and resources related to the topic

## Language focus

- Vocabulary related to sustainable development
- Practice in writing sentences and giving information on environmental issues

## SDG focus

- SDG 11: Sustainable cities – Innovative ideas and solutions to problems concerning sustainable urban development

## Creative focus

- Creative problem-solving

Level A2 and upwards

Age 12 years old and older

Time 60–90 minutes

## Procedure

- At the top of the board write the name of the town/city where you are currently teaching (or the nearest large town). Underneath it, draw a vertical line dividing the board in two. Write '+' and '-' on each side of the line. Ask the students to brainstorm in groups the positives and negatives of life there. Allow five minutes for this.
- When time is up, elicit their ideas and write them on the board in the two columns.
- As a whole-class activity, ask the students to put into sentences the ideas they have come up with. Invariably, there will be examples such as 'We need more public transport' or 'There are too many cars' or 'I wish this place was safer at night' or 'There's too much pollution.'
- Use the examples as a lead-in to the introduction of SDG 11.
- Ask the students in the same or new groups to come up with some possible solutions for how some of these problems could be solved.
- A representative from each group then presents their initial general ideas to the class. (It should be made clear that their solutions don't have to be specific but general in nature, and that they have unlimited funds for overcoming these difficulties.)
- Depending on the level of the students, introduce grammar and vocabulary exercises here. For lower levels, the use of countable and uncountable nouns and expressions and the consolidation of vocabulary/expressions specific to this topic could be used. See the resources section for available websites and lessons.

- Select and show YouTube videos about the topic to the class. Included in the resources section are links to useful videos such as 'Curitiba: How a Brazilian city has revolutionized sustainable planning' and 'Masdar: City of the future'.
- Consolidate vocabulary and ideas. For homework ask the students to search for more information and online videos. Ask each group to find a poem relating to sustainability and the environment.
- Introduce the main task: in groups they will be required to make and present a 10–15 minute video presentation on the themes brought up in the class. They must use a poem they wrote together and they must all participate in the video presentation.

## Additional resources

Journeyman Pictures

- How a Brazilian City Has Revolutionized Urban Planning: <https://youtu.be/hRD3l3rIMpo>

Fully Charged

- Masdar: The City of the Future: <https://youtu.be/Nlaz61zpLfs>

## Activity 2: Paved paradise

### Aim

- To introduce students to poems/videos/speeches related to environmental and sustainability issues

### Language focus

- Vocabulary acquisition
- Expressing opinions and emotion

### SDG focus

- SDG 11: Sustainable cities – Exploring positive images of cities through poetry

### Creative focus

- Students explore creatively different writing styles and are exposed to language devices such as puns, metaphors, similes, irony and humour by writing concrete poems on sustainable cities.

Level A2+

Age 12 years old and older

Time 60–90 minutes

### Preparation

- Ask students to prepare a poem about a city to read to the class. They can search for poems about cities on: <http://www.poemhunter.com/>



## Procedure

- Ask each group to first read the poem they brought in to another group and afterwards exchange copies.
- Each student in the group now silently reads over this new poem.
- Each group now gives a summary of the poem they brought in to the class. They then read it aloud again.
- After this, give them the following words and ask them to write a short poem which must contain the given words. Make sure they understand the words first:  
o paved farmer apples paradise museum
- Tell them not to think too much or to worry about accuracy.
- After finishing, they read out their poems.
- Select interesting and useful examples from what they have written and record them on the board.
- Tell students that the five words were taken from a famous song from the 1960s by Joni Mitchell called 'Big Yellow Taxi'.
- Play the song for them – you can easily find a version on YouTube or any other video or audio sharing site.
- Discuss its meaning. Hand out the lyrics and ask them to read them as you play the song again. (You can find the lyrics by typing 'lyrics big yellow taxi' into Google.)
- Contrast and compare students' poems with the original.
- Remind them that for their video presentation they have to write a group poem on sustainability in an urban environment.
- They must use five of the following words in their poem:

infinity	tomorrow	
		change
children		
		dawn
	beauty	
		trapped
hearts	hollow	earth

- Alternatively, you can choose your own words or have the students generate random words.
- Allow them plenty of time for writing the poems. They do not need to complete the poem by the end of the class but they do need to have it ready for the final presentation. Ideally after they have finished it they should ask you to check it sometime before the final presentation.

## Activity 3: A city poem

### Aim

- To give students the platform, means and mode to showcase their creative videos

### Language focus

- Presentation skills, especially pronunciation

### SDG focus

- SDG 11: Sustainable cities

### Creative focus

- Making a video

Level A2+

Age 12 years old and older

Time 60–90 minutes, plus time outside class

### Preparation

- Make sure students bring in smartphones and/or video cameras.

### Procedure

- Explain that, in groups of four, they will be making a video about some aspect of sustainable cities. Remind them of some of the issues already discussed.
- They will need to discuss and decide on the content or storyline for their video, the writing of the script, the number and type of shots they will use and their length. They may decide to participate in the video as actors or rely on a voice-over commentary to accompany the shots. Most students will have smartphones, so making the videos should present no technical problems.
- Remind them that they should include at least one poem in their video.
- Encourage them to meet out of class to work on their videos.

- Before the final presentations, check through the videos with each group to ensure they work and that playing them in the classroom will present no problems.
- The students watching the video presentations of other groups must participate actively. One way of doing this is to allocate specific tasks to the students who are viewing. For example, some can note down questions to ask, others can prepare to give written feedback to the presenting group.
- After the video has been shown, there will be a question and answer session focusing on what was presented and the problems encountered in making the video.

### Follow-up

- Students put together a collection of the best videos on each topic.
- A collection of their poems is published by the college, on the class website, as a wall display or by self-publication.
- A textbook of creative lessons by the students in association with the teacher is developed.
- Set a self-reflection assignment in which students will reflect on the activities and write a 500-word reflection touching on some or all of the following areas:
  - o How did you feel during the stages of making this video?
  - o What problems did you and your team encounter? How did you overcome them?
  - o What did you like/dislike about this activity?
  - o What did you learn?
  - o Was this project useful for your language development?
  - o Would you like to do this kind of activity again?
  - o What other topics would you like to cover?

### Additional resources

#### Brazilian city of Curitiba

- How a Brazilian city has revolutionised sustainable planning. Useful ideas and language: <https://www.youtube.com/watch?v=hRD3I3rIMpo>

#### Ted Talk: How we design and build a smart city and nation

- Useful ideas and language: <https://www.youtube.com/watch?v=m45SshJqOP4>

#### Masdar: City of the future

- Useful ideas and language: <https://www.youtube.com/watch?v=Nlaz61zpLfs>

#### Science Rhymes

- Science and environmental poems: <http://www.sciencerhymes.com.au/environmental-poetry>

#### Hello Poetry

- Poems on sustainability: <http://hellopoetry.com/words/126241/sustainability/poems/>

#### Poetry Soup

- Various and interesting poems: [http://www.poetrysoup.com/poem/sin\\_city\\_760428](http://www.poetrysoup.com/poem/sin_city_760428)

#### Larrick, Nancy (ed) (1968) On City Streets. New York: M Evans and Co.

#### Goodreads

- Useful quotes connected with sustainability: <http://www.goodreads.com/quotes/tag/sustainability>

#### My English Pages

- Useful site for vocabulary relating to sustainable development: [http://www.myenglishpages.com/site\\_php\\_files/vocabulary-lesson-sustainable-development.php](http://www.myenglishpages.com/site_php_files/vocabulary-lesson-sustainable-development.php)

#### Sustainable Vocabulary

- Very useful free site where you can get flashcards of terms and expressions related to sustainable development: <https://quizlet.com/6712073/sustainability-vocabulary-flash-cards/>

## References

- Burton, P (2010) Creativity in Hong Kong schools. *World Englishes* 29(4): 493–507.
- Cheon, LB (2013) Suggestions for language learners: Creativity development in EFL classroom. *Primary English Education*: 19–3.
- Cook, G (2000) *Language Play, Language Learning*. Oxford: Oxford University Press.
- Gilmore, A (2007) Authentic materials and authenticity in foreign language learning. *Language Teaching* 40, 02: 97–118.
- Maley, A (1997) 'Creativity with a small "c"', in C Coreil (ed.), *The Journal of the Imagination in Language Learning and Teaching*, 4. Retrieved 1 March 2004 from <http://files.eric.ed.gov/fulltext/ED420199.pdf>
- Maley, A (2014) Taking a chance on chance. *Folio*, vol.16, 1.
- Mishan, F (2005) *Designing Authenticity into Language Learning Materials*. Bristol: Intellect Ltd.
- Spiro, J (2004) *Creative Poetry Writing*. Oxford: Oxford University Press.
- Tan Bee Tin (2013) Towards creativity in ELT: the need to say something new. *ELT Journal*, vol. 67, 4.
- Tomlinson, B (ed.) (2003) *Developing Materials for Language Teaching*. London: Continuum.



# 13

## Sustainable Development Goal 12: Ensure sustainable consumption and production patterns

László Katona and Nora Tartsay

### Introduction

The aim of the chapter is to highlight the importance of scientific and technological awareness of sustainability in production and consumption. One of the major goals of the UN Sustainable Development Goals (SDGs) is to achieve sustainable management and efficient use of natural, non-synthetic resources and to reduce the amount of global energy, food and water waste. The amount of food loss is horrifying; according to the UN, one third of the food produced each year is wasted. The patterns in energy waste and water pollution are also appalling. However, we must be aware that we hold a tremendously important weapon against these patterns in our hands: education.

Only through conscious education and educational environmentalism can we face these sustainability issues. This means that teachers must also become more aware of production and consumption of food, energy, water, etc. We are concerned that the topic should be addressed by all teachers, from different perspectives, and not by science teachers alone. By means of state-of-the-art teaching methods, teachers of English as a foreign language must integrate these topics into the English classroom to promote an understanding of the global environmental threats of the 21st century.

In this chapter, a mixed method of chemical experimenting and media studies will be demonstrated through which English language teachers can simultaneously approach these environmental and global issues from both natural sciences and linguistic perspectives.

The language learning focus throughout the chapter is mainly practising academic language (presentations, scientific scripting, report writing, infographic presentation) and the language of scientific documentaries, as well as developing skills for writing voice-over scripts.

The chemistry experiments described in the chapter allow the practice of various grammar points and science-specific vocabulary. The language level can be adjusted to the level of the group by the teacher, by pre-teaching vocabulary or offering more language support.

The creativity focus of the tasks in this chapter is the use of smartphone-related ICT techniques. Typically, in each class there will be many students equipped with smartphones. Such is the speed of technological development that these are now more powerful than those used in the space module that landed on the Moon! Learners are extremely motivated by taking photos or recording short videos, which is now also considered a valid way of collecting data in the sciences. Teachers can exploit this to open students' eyes, and help them produce meaningful and creative media products that raise their and their peers' awareness of the world we live in. Further work can include experimenting with other media genres as outcomes (news broadcasts, interviews, photo exhibitions) and focusing on alternative hands-on experiments in other natural sciences. The methods described in this chapter can also be used in long-term projects involving data collection, long-term observation and more language work.

The chapter is closely connected to sustainable consumption and production goals, which focus on limiting the use of natural resources while simultaneously increasing the efficiency of production of goods and services. There is a need to raise awareness of water-, energy- and food-related information, which is also the aim of the experiments in this chapter.

We will introduce three chemical experiments with ICT-based creative tasks and exercises. Each experiment will have clear instructions for the teacher and the students, with task sheets. Teachers can alter the tasks to match their students' needs.

- The first experiment is connected with washing powders and their impact on water pollution.
- The second experiment may serve as an introductory activity for classes on energy consumption and CO<sub>2</sub> emissions. In the course of the second experiment students will gain hands-on experience of the physical characteristics of CO<sub>2</sub>.
- The third experiment is an introductory activity for classes on sustainable food production and consumption by showing how sugar can behave with different catalysts.

## Activity 1: Reducing pollution from household waste water

### Aim

- To raise awareness of pollutants in household waste water that may lead to eutrophication. Eutrophication is the depletion of oxygen in water resulting in the extinction of animals.

### Language focus

- Comparative structures (positive, comparative and superlative forms) and academic writing

### SDG focus

- SDG 12 – Focusing on the reduction of the release of waste material into the environment

### Creative focus

- Creating a photo diary based on the science experiment. The diary will contain the report book of the experiment (sample provided) and photos to be compared.

Level A2–C1

Age 12+

Time 3 x 45 minutes

### Preparation

- You will need the following materials:
  - o 3 pieces of 20 cm x 20 cm fabric with three stains (chocolate, grease/oil and ink)
  - o 3 x 1 litre of tap hot water (approximately 40–45°C)
  - o 10 pieces of soap nut
  - o 2 teaspoons of soda
  - o 2 teaspoons of synthetic washing powder/gel
- You will also need the following tools:
  - o 3 x 1.5-litre bowls (transparent glass recommended)
  - o 3 sticks for stirring
  - o wiping cloth
  - o digital camera/smartphone camera
  - o paper and (multicolour) pen, pencil, felt-tip pen
- Also make copies of Worksheets 1 and 2.

### Procedure

- Put the students into groups and give them Worksheet 1 to discuss.

- Ask them to do some research to try to find the answers before the next class.
- In the next class, tell the students they will experiment with the washing capacity of naturally occurring soap nuts, soda and synthetic washing compounds.
- Put the students into groups of three.
- The students should decide on their roles:
  - o The scientist will be responsible for doing the experiments.
  - o The observer will fill in an observation sheet.
  - o The photographer will take photos and analyse the before and after photos.
- Ask students to follow their roles during the experiment (conduct, observe, take photos, complete the diary).
- Conduct the experiment in Worksheet 2.
- Once they have completed the experiment, bring the class together so that the groups can compare notes. Get them to discuss these things:
  - o Sum up the results of the experiment.
  - o Which detergent would you recommend for the protection of the environment?
  - o Why? Share your arguments.

### Follow-up

Get students to prepare a presentation of their research and findings.

### Materials

There are two worksheets (the preparatory and the experimenting lesson worksheet), and two templates (the record book and the photo diary) are provided (see below).

### Worksheet 1: Discussion

Answer the following questions:

1. Which type of detergent do you use at home?
2. How many times a week do you wash your clothes?
3. What do you think happens to the stains during washing?
4. What materials does the waste water contain?
5. What effects do these materials have on the environment?

## Worksheet 2: Experimenting

Work in groups of three. You are going to experiment with the washing capacity of naturally occurring soap nuts, soda and synthetic washing compounds.

You are expected to experiment and observe, as well as photo-record your work.

### Scientist

Wash the three pieces of stained fabric with different detergents following the instructions below.

- Stain the pieces of fabric (identical size) one day before the experiment as in this sample:



- Wrap 3–4 soap nuts in the first piece of fabric, spread a teaspoon of synthetic washing powder or gel on the second piece of fabric and then spread a teaspoon of soda on the third piece.
- Mark the bowls A (soap nut), B (washing powder/gel) and C (soda), and fill them with 1 litre of tap hot water (40°C).
- Put 6–7 pieces of soap nut into Bowl A and stir for 20 seconds.
- Put a teaspoon of washing powder/gel into Bowl B and stir until it is fully dissolved.
- Put a teaspoon of soda into Bowl C and stir until it is fully dissolved.
- Put each fabric into the corresponding bowl of water and stir vigorously for two minutes, then let it rest for two minutes. Repeat this sequence three times: Phase 1, Phase 2, Phase 3.
- Remove the pieces of fabric, put them in cold water and rinse for 15 seconds. Squeeze them and observe.
- Take notes on your observations throughout the experiment.

Decide who will be:

- scientist
- observer
- photographer

### Observer

Record all the changes you observe during the washing of the three pieces of fabric with different detergents. You will need to make notes for a report book and photo diary.

### Photographer

Use your mobile device to take photos of the different phases (initial state, the starting point, in-between and the final outcome). Make sure you record all changes in all three bowls, before and after rinsing.

## Activity 2: CO<sub>2</sub> fire extinguisher

### Aim

- To help students understand the characteristics of carbon dioxide/CO<sub>2</sub> (agent produced through the burning of fossil fuels and organic materials)

### Language focus

- Academic writing, script writing and summarising skills
- To practise the language of scientific documentaries and develop skills for writing voice-over scripts

### SDG focus

- SDG 12 – To promote the understanding of the significance of CO<sub>2</sub> emissions.

### Creative focus

- Creating short, two-minute scientific documentaries based on the science experiment, writing short scripts for the audio recording, creating the voice-over narrated video.

Level B1+  
Age 14+  
Time 15–30 minutes

## Preparation

For the experiment you will need the following tools and materials:

- 3 teaspoons of baking soda
- 1 litre of vinegar
- 1 litre volume container
- 5–10 tealight candles
- matches
- a smartphone or video camera.

You will also need to make copies of Worksheet 1.

## Procedure

- Put the students into groups of three and give them the experiment worksheet and ask them to read through it.
- Make sure they have decided on their roles and that one student has a video camera to film the experiment.
- Give the students the equipment and resources they need and a safe place to carry out the experiment.
- Make sure they know what to do and get them to do the experiment and record it.

### What happens:

- o The vinegar generates gas upon contact with the layer of soda.
- o The gas collects and stays in the pitcher/pot.
- o The gas puts out the candles when poured on them.

### Explanation:

- o Weak acids can be liberated from their salt by a stronger acid.
- o Baking soda is the salt of soda water (carbonic acid  $\text{H}_2\text{CO}_3$ ), which is a weaker acid than vinegar. Vinegar liberates carbonic acid from baking soda.
- o Carbonic acid immediately disintegrates into water and carbon dioxide.
- o Carbon dioxide is heavier than the air so it collects at the bottom of the container.
- o As it is heavier than air, it can be poured.
- o Carbon dioxide suffocates fire/flames.

- Once the students have completed the experiment, ask them to add a voice-over to their video explaining what is happening.
- When they have finished, ask them to think about how this relates to CO<sub>2</sub> emissions.

## Follow-up

- Organise a presentation class where each group can screen their video. Compare the outcomes.

## Materials

### Worksheet 1: The experiment

Work in groups of three.

- Scientist – should handle the experiment.
- Cameraperson – should use their camera to video record the experiment.
- Director – should make sure everything is done properly and recorded.

### Begin the experiment:

- Put the baking soda into the pitcher/pot (1 cm thick layer).
- Pour some vinegar onto the layer of baking soda (1 dl). (WARNING: do not shake the pitcher/pot.)
- Place the candles on the desk and light them.
- Slowly start pouring the gas generated in the pot over the candles.

## Activity 3: Burning a sugar cube

This activity introduces glycolysis, which is a metabolic process for the degradation of glucose into certain acids and energy. All the food we consume will eventually be turned into glucose which will be oxidised by enzymes (catalysts in the human body). Sugar (glucose) is a molecule that can be burnt in the presence of ash due to its potassium content.

The experiment in this task focuses on the catalysed burning of sugar cubes analogous to the process of enzymatic burning of sugar molecules in the body.

### Aim

- To introduce an elementary process of food chemistry to raise awareness of food consumption

### Language focus

- To practise conditional sentences



## SDG focus

- SDG 12: Sustainable food production and consumption

## Creative focus

- Creating short infographics based on the experiment. Typical elements of an infographic are short texts, photos, graphs, drawings, diagrams, timelines, checklists, maps, etc.

Level B1–C2  
Age 14+  
Time 15 minutes

## Preparation

You will need to bring the following tools and materials into class:

- sugar cubes
- ash from cigarette, paper, leaves or wood, etc.
- metal tray/tile
- fire-proof thongs
- large jar of water
- matches/lighter
- a pair of tongs.

You will also need to make copies of Worksheet 1.

## Procedure

- Tell your students you are going to show them an experiment.
- Show them the sugar and tell them you are going to burn it.
- Ask them what they think will happen.
- Now place the sugar cubes on the tile.
  - o Try to set light to the first sugar cube. Let the students observe what happens.
  - o Now take some ash and spread it over the other cube.
  - o Try to set this sugar cube on fire. Let the students observe what happens this time.

## What happens:

- o The first cube without ashes will not catch fire, though due to the heat, the sugar becomes caramelised.
- o The second cube with ash catches fire and will burn with blue flames.

## Explanation:

- o The ash contains a large amount of potassium ions in the form of potassium oxide and potassium carbonate, which catalyse the burning of sugar.
- If you think it is safe you can now let your students carry out the same experiment.
- Ask them to work in groups of three.
- Once they have finished, give them Worksheet 1 and ask them to complete the sentences.
- Check and correct the sentences.
- Now ask the students to produce an infographic showing the experiment they carried out and the results.

## Materials

### Worksheet 1: Experiment observations

Complete the sentences below.

The first has been done for you.

If we set a sheet of paper on fire,  
it will burn and ashes will be left behind.

If we burn a sugar cube,  
it

\_\_\_\_\_

If we keep burning the sugar cube, it

\_\_\_\_\_

If we burn the sugar cube some more, it

\_\_\_\_\_

If we burn a sugar cube coated with ash, it

\_\_\_\_\_

If we do not add ash, the sugar cube

\_\_\_\_\_

## **Additional resources**

YouTube – Glycolysis: An Overview

- This is a simplified video on glycolysis:  
<https://youtu.be/8Kn6BVGqKd8>

## **Further resources**

Cleaning Institute – Science of Soap

- This site helps students understand how soap works: <http://www.cleaninginstitute.org/stem/>

Learning Coach – Writing V/O Scripts

- This site offers help on the dramaturgy of voice-over scripts / writing skills development:  
[http://thelearningcoach.com/elearning\\_design/the-art-of-writing-great-voice-over-scripts/](http://thelearningcoach.com/elearning_design/the-art-of-writing-great-voice-over-scripts/)

Wikihow – Doing V/O

- A little help on how to do voice-over recordings:  
<http://www.wikihow.com/Do-a-Voice-Over>

United Nations – Sustainable Consumption and Production

- This site is a blog site with video reports and media content on the topic: <http://www.un.org/sustainabledevelopment/blog/category/video-sustainable-consumption-and-production/>
- Show them the sugar and tell them you are going to burn it.

# 14

## Sustainable Development Goal 13: Take urgent action to combat climate change and its impacts

Maria Theologidou

### Introduction

For over ten years now, climate change has become something bigger than the plot of science fiction films and alarming natural disaster documentaries. It is a stark reality affecting the lives of us all as it has changed the present and the future prospects of millions of people around the world. It is therefore one of the most important issues teachers should prepare their students for, so as to make them aware of the global impact climate change has had and will have.

The purpose of the activities suggested below are threefold: to raise students' awareness of energy issues, to encourage climate action and to engage students in hands-on tasks that allow them to design a better, sustainable future. The approach followed mostly touches on project-based learning (PBL) and makes use of KWL (Know – Want to Know – Learned) charts. It aims to offer students the ability to practise grammar and vocabulary in creative ways so that language can be seen as a tool which can promote global understanding and make students active agents of change in today's world.

The activities suggested are mainly for B1- to C1-level students but can be adapted for younger and lower-level classes. They are primarily designed for relatively small classes in language schools and can be used in both minimal-resource and high-resource environments. They focus on three areas of interest:

- types of energy
- energy and global warming
- designing sustainable cities.

All the activities are linked, so that the ultimate aim of designing sustainable environments can be seen as a natural development from the energy sources discussion. They are also designed in such a way that they can either be worked on as a full-scale project which can run for a number of weeks or as independent mini-sessions throughout the year. The main goal is to encourage the idea that creativity and awareness can go hand in hand and can be promoted by all teachers.

### Activity 1: Energy, where art thou?

#### Aim

- To identify and differentiate between different types of energy and suggest solutions to household energy waste

#### Language focus

- Energy-related vocabulary
- Practice of second conditional structures
- Language used for suggestions

#### SDG focus

- SDGs 13 and 7 – Raising awareness of energy issues, especially energy consumption and alternative forms of energy as they relate to climate change

#### Creative focus

- This activity draws mostly on building critical thinking and teamwork through creativity, as students use sticky notes to provide innovative solutions for energy-related problems.

Level	B1+ to C1
Age	13–16 years
Time	45–50 minutes

#### Preparation

- You will need sticky notes/Post-its (preferably of two different colours), two pieces of construction paper (same colours as the sticky notes) and the 'World energy report' infographic: <http://c1cleantech.com/wpengine.netdna-ssl.com/files/2011/09/world-energy-report.jpg>.
- Before coming to class ask your students to take pictures of rooms/areas in their homes showing devices/appliances that consume energy.

## Procedure

- Write the word 'Energy' on the board, then ask students to look around their classroom and identify as many sources of energy as they can. Encourage them to share their findings so that you can create a mind-map around the word 'Energy' based on their suggestions. Write the mind-map on the board.
- Divide students into groups of three or four. Hand out the sticky notes and two sheets of construction paper. Tell them that the two colours correspond to renewable and non-renewable sources of energy respectively. Ask them to use the notes to group the different types of energy into renewable and non-renewable ones. They should stick the notes for each category of energy to the two different pieces of construction paper.
- When students finish, ask them to mention two or three things they already know about renewable/non-renewable forms of energy. Show them the 'World energy report' infographic. Ask them why they believe excessive energy consumption matters.
- Write on the board 'If we ..., our homes would be more friendly to the environment'.
- Elicit possible answers for the first gap (e.g. If we unplugged devices when we aren't using them / If we used less electricity, etc.).
- Tell students that they will have to spot energy waste sources in their classmates' pictures (the ones they have brought from their homes) and that they will give them advice.
- Ask your students to brainstorm language used for advice (Why don't you ... / How about ... / Perhaps you could ... / You should definitely ...)
- Students now share the pictures of their homes. In their groups, students identify possible energy issues in their classmates' homes. They do so by sticking the notes to the 'energy-harming' parts of the different pictures, explaining briefly what they think the problem is, using the second conditional structures and language for advice.
- Each group is given a picture and asked to come up with three or four different ways to solve this energy problem.

## Follow-up

- As homework, give out Worksheet 1: Energy waste and ask your students to create a longer list of six to eight solutions to the different energy issues they spotted in the pictures they used in class. Encourage them to present their solutions in class using a web tool such as Canva: <https://www.canva.com/> or Thinglink: <https://www.thinglink.com>.
- If you are interested in extending the activity, you could also make use of the outside area of the school and create an energy-related 'treasure hunt' to spark students' curiosity. You should simply use sticky notes on light switches or lamps/desktops available in the places students will walk through before coming to your class. Write questions on them such as 'Did you remember to switch me off today?', 'How many hours am I plugged in at home?', etc. The questions can vary depending on your students' level.

## Materials

### Worksheet 1: Energy waste

As we've seen in class, energy waste is a big issue nowadays! There's a lot we can do about it, so let's start from the place where we spend most of our time – our home. In class, you've all spotted energy waste problems in your classmates' pictures. Now, put together six to eight tips that we can all follow if we want to make our houses greener!

#### Examples of energy waste to consider

Problems	What to look for	What to do
Lights	Are lights off when you or members of your family aren't in a room? Do you use energy-efficient light bulbs?	
Appliances	Do your appliances have Energy Star ratings? Do you switch them off/close them when you don't need them?	
Other devices	Are your computers, TVs and game consoles on standby or off when you aren't using them? Do you remember to unplug your phone charger?	
Water	Do you leave the tap running? Do you take short showers or long baths? Do you use the washing machine more than three times a week?	
Insulation	Are there any old windows or doors in your house? Is there anything you can do to improve them?	
Heating/Cooling	Do you keep the windows/doors closed/open when the air conditioning or heating is on?	

#### Additional resources

##### Energy Literacy videos

- This is a great introduction video to what energy is and how it impacts our everyday life: <http://energy.gov/eere/education/downloads/energy-literacy-videos>

##### EIA Energy Kids

- This site is ideal if you're interested in working on the same activity with younger classes: <https://www.eia.gov/kids/energy.cfm?page=2>

##### Cleanet.org – Energy quiz

- This is an online quiz to test students' energy awareness: <http://cleanet.org/clean/literacy/energyquiz.html>

## Activity 2: A greener house, a greener planet

### Aim

- To use the vocabulary and suggestions from Activity 1 along with the structures presented to design and improve houses/devices to be more friendly to the environment

### Language focus

- Developing public-speaking skills
- Practise vocabulary relating to houses and machines

### SDG focus

- SDGs 13, 11 and 17 – Through this first building task, students become more aware of how conventional houses/appliances can become more environmentally friendly in order to meet the demands of climate change.

### Creative focus

- Engagement in a project that allows them to create their own green building/devices and boosts teamwork skills

Level B1–C1  
Age 13–16 years  
Time 60 minutes

### Preparation

- Provide students with large pieces of canvas paper where they can design the blueprints of their devices and green homes.

### Procedure

- If you have not worked through Activity 1, provide students with pictures of houses (you could also use pictures of your own house) and household appliances and introduce them to energy waste in households.
- Divide students into groups of four and explain that they will be discussing how they could improve houses and design appliances so as to minimise energy waste. It is best to have an equal number of home improvers and appliance designers.
- Ask the groups to imagine they own their own company. Using the pictures of conventional houses/appliances, they need to think of ways to improve homes or to create domestic energy-saving devices, so as to protect the environment and reduce the impact on climate change.
- Hand out the pieces of canvas paper and tell them that in each team there will be two designers and two presenters.

- The designers will have to create the design of the house or the device. They will need to draw the different parts of it and write a short paragraph beneath their design explaining how their suggestions will make buildings greener or how their device works. The presenters should prepare a short speech explaining the benefits of their suggestions for the environment.
- The presenters then present their designs to the rest of the class, say how they are different from the conventional houses/appliances and answer any questions their classmates raise.

### Follow-up

- As a follow-up, students write reports on how the activity has helped them become more familiar with energy consumption and the way green energy could be promoted and used more widely so as to reduce impact on climate change.
- Using recyclable materials they can find at home, students build their devices or create models of their improved houses and bring them to class next time.

### Additional resources

Ghana's Eco-friendly Bamboo Bikes

- This video is perfect if you want to show your students examples of eco-friendly transportation: <https://www.youtube.com/watch?v=8YHH-lq-0ac>

Room Sketcher – Designing your own house

- Instead of designing on paper, students could use this tool to create the blueprints of their houses: <http://planner.roomsketcher.com/#/?pid=3028842>

## Activity 3: Energy and humans

### Aim

- To relate the energy topics previously discussed to the larger issue of global warming and its impact on climate

### Language focus

- Third conditionals
- Unreal past (It's high time + s. past)

### SDG focus

- SDG 13: Climate change – Reflection on global warming and the connection between individual energy use and global energy issues

## Creative focus

- Critical thinking skills and use of students' imagination to visualise how the world can be further affected by global warming.

Level B1+ to C1  
Age 13–16 years  
Time 45–50 minutes

## Preparation

- Select and print copies of some of the global warming quotes found here: [http://www.brainyquote.com/quotes/keywords/global\\_warming.html](http://www.brainyquote.com/quotes/keywords/global_warming.html).
- You will need to be able to access these global warming before-and-after pictures:
  - o <http://news.nationalgeographic.com/2015/12/151229-before-after-earth-features/>
  - o <http://climate.nasa.gov/images-of-change?id=590#590-porcupine-glacier-calves-in-british-columbia>.
- You will need to be able to access The Royal Society's video on global warming: <https://www.youtube.com/watch?v=n4e5UPu1co0>.

## Procedure

- Show your class The Royal Society's one-minute video on global warming above.
- After watching, ask students which words stood out for them from the video.
- Write on the board statements used to express opinions (I think ... / I feel ... / I'm afraid I'll ... / As far as I'm concerned ..., etc.).
- Then, show your students the before-and-after pictures of global warming and ask them to tell you how they feel about them, preferably using some of the expressions on the board.
- Clear a space for students to stand up. Present them with some global warming facts.
  - o Tell them that the far right side of your classroom represents 'Yes/I agree' and the far left side of the class is 'No/I disagree'. Now, tell them that after hearing each statement they should move to the right or left side of the room according to whether they believe the facts are true or not. If they are unsure, they can move to an intermediate position.

- Hand out the quotes on global warming. Each student has one or two minutes to say how they feel about their quote.
- After this, write 'If we had stopped ..., we wouldn't have' and 'It's high time we ...' on the board.
- Using some paper, students write three statements using these structures on what they feel has happened because of global warming.
- They then choose one of their three statements and write it on a piece of paper and put a scale of 0–5 next to their statement.
- Students now exchange papers and rate their classmates' statements.
  - o They should use the 0–5 scale next to each statement and circle a number according to how much they agree with their classmate's statement.
  - o Statements could vary from 'If we hadn't wasted so much water, many parts of the world wouldn't have become deserts' to 'It's high time we started taking energy conservation more seriously.'
- If they want to, they can also write a comment below their classmate's statement (for example, 'I totally agree with your statement and wish more people felt the same').

## Follow-up

- You could ask your students to search for films or documentaries on the issue of global warming and to present them in class.

## Additional resources

Daltonic Films – Short film about global warming

- A film about climate change and how it has affected the life of people living in the Andes: <http://daltonicfilms.com/project/trouble-at-the-top-of-the-world/>

Energystar.gov – Global warming and energy issues

- If you are interested in adapting the same activity and using it with younger classes, this site has a useful slideshow on global warming along with extra links on energy issues: [https://www.energystar.gov/index.cfm?c=kids.kids\\_index](https://www.energystar.gov/index.cfm?c=kids.kids_index)

www3.epa.gov – A student's guide to global climate change

- This is a site for older kids which further explores the issue of global warming: <https://www3.epa.gov/climatechange/kids/index.html>

## Activity 4: Before and after

### Aim

- To deepen students' understanding of global warming and encourage them to think more creatively about what could be done /could have been done to prevent environmental disasters

### Language focus

- Using modals to discuss possible scenarios

### SDG focus

- SDG 13: Climate action – Raising awareness of the actual damage global warming is causing

### Creative focus

- Writing poems to express feelings about global warming

Level B1–C1  
Age 13–16 years  
Time 45–60 mins

### Preparation

- You will need copies of the KWL charts (KWL is the abbreviation for Know/Want to know/Learned) for this activity like this one on the ReadWriteThink website: <http://www.readwritethink.org/classroom-resources/printouts/chart-a-30226.html>.
- You also need the link to the before-and-after pictures used for the previous activity:
  - o <http://news.nationalgeographic.com/2015/12/151229-before-after-earth-features/>
  - o <http://climate.nasa.gov/images-of-change?id=590#590-porcupine-glacier-calves-in-british-columbia>.

### Procedure

- Hand out the KWL charts. Ask students to write down one or two statements that represent what they already know about global warming.
- Show them the before-and-after pictures. Every time they see a picture, ask them to write down one word which describes how they feel about it.
- Then write in the middle of your board in a cloud-shaped speech bubble the expression 'What if ...?'
- Ask your students to share the words they wrote down during the picture task. Write these on the board.

- Now you have students' words on the board, write at the top/bottom corner of the board the modals 'could', 'should', 'would' and 'must' along with their modal perfect equivalents 'could have', 'should have', 'would have' and 'must have'.
- Elicit the modals' uses and remind your students of any differences in meaning when the modal perfect form is used. For example, 'must + present infinitive' often expresses obligation or duty, e.g. 'You must eat your yoghurt', but we use 'must + perfect infinitive' to express certainty or make a logical assumption about a past action, e.g. 'He must have come while we were out'. Similarly, 'should + present infinitive' is used for recommendation or advice, e.g. 'You should be more careful', whereas 'should + perfect infinitive' is often used to express criticism and annoyance, e.g. 'You should have asked how much it was'.
- Students come to the board, one by one. Ask them to think of what could make them change how they felt about the after pictures they saw.
- Using any one of the eight modals, students take turns to share their sentences. For example, 'We should stop wasting water', 'We could have learned more about energy conservation when we were younger', 'We must use alternative forms of energy', etc.
- Every time a student finishes, they erase the modal they have used from the board. At the end of the activity the only expression left on the board is 'What if ...?'
- Complete the 'What if ...' question in your own words as if you were writing a short rhyming verse, e.g.
  - o What if we protected our home more,  
stopped cutting down trees and polluting  
the shore?  
We could change the world, that's for sure.  
A green lifestyle is the cure.
- Ask them to brainstorm words that relate to the environment, e.g. protection, green, emission, deforestation, fishing, etc.
- Ask them to try to find words that rhyme with these words, e.g. conservation, keen, mission, frustration, wishing, etc.
- Students work in groups of three or four and write some rhyming verses using the structure 'What if ...?' and the words on the board.



## Follow-up

- You could work on the other two columns of the KWL chart and discuss what your students have learned from the activities and what else they'd like to know about the impact of global warming.

## Additional resources

Readwritethink.org – Poem interactives

- If you have access to a computer lab, students could create their poems using this site's poem interactives: [http://www.readwritethink.org/search/?resource\\_type=16&type=28](http://www.readwritethink.org/search/?resource_type=16&type=28)

BBC – Climate Challenge game

- This game is especially suitable for older students since it enables them to think more critically about the decisions involved in tackling climate change: [http://www.bbc.co.uk/sn/hottopics/climatechange/climate\\_challenge/](http://www.bbc.co.uk/sn/hottopics/climatechange/climate_challenge/)

## Activity 5: Stepping into action

### Aim

- To introduce the process of designing sustainable environments. Also to help students practise their speaking and writing skills and use topic-related vocabulary

### Language focus

- City-related vocabulary and environmental problems

### SDG focus

- SDGs 13 and 11 – This is the first of the two activities on sustainable development and raises students' awareness of the environmental problems their city faces.

### Creative focus

- Active role play/dramatisation to explore the pros and cons of green development

Level B2–C1+

Age 14–17 years

Time 50–60 minutes

### Preparation

- Using Google maps, find three or more pictures of different areas in your city and make copies.

## Procedure

- Write the name of your city on the board and ask students to brainstorm words that they associate with their city.
- Group the vocabulary into positive and negative words. Ask them to notice which group has more words and ask them why they think that is.
- Hand out the worksheets with the three pictures of different areas of your city and ask students to notice any similarities/differences between the pictures.
- Ask them to identify any problems they notice from the images, e.g. traffic congestion, old buildings, lack of green areas, etc.
- Ask them to think about how their city could be improved and give them time to complete the table with their ideas.
- Divide the class into three groups – environmentalists, designers and citizens – and explain each group's role.
  - o Environmentalists need to think of how the city can become a greener place.
  - o Designers need to think of materials or resources they could use towards turning the city into a sustainable space.
  - o Citizens should focus on ways to promote sustainability for people in their community.
- Students work in groups and complete the questions on Worksheet 1: Stepping into action.
- Encourage them to use online resources if they have phones with internet access and to look up new vocabulary.
- They should write down their ideas in bullet-point form. They should express their views in their own words and not worry too much about specialised terminology.

### Follow-up

- As homework, students should take pictures of their neighbourhood or other areas of the city which they will need for the second activity below (Activity 6).

## Materials

### Worksheet 1: Stepping into action

How do you think our city could become a greener place to live? Fill in the chart with your suggestions.

<b>Traffic</b> (numbers of cars/buses)	<b>Green areas</b>	<b>Buildings</b>	<b>Transport</b>

You're a member of each one of the following groups. Work with your team and try to come up with ideas about making our city a more eco-friendly place.

<b>Architects – Engineers</b>
Ideas for eco-friendly buildings/sustainable transportation

**Environmentalists**

Ways to create more green areas

**Citizens**

Spreading the message – raising people’s awareness

## Activity 6: Revisiting our neighbourhoods

### Aim

- To involve students in improving the places where they live by realising what sustainable development entails in practice

### Language focus

- Students will recycle and consolidate the vocabulary and structures they have already been introduced to

### SDG focus

- SDGs 13 and 17 – Students discover more about sustainability in urban environments

### Creative focus

- This second building project shows students how to create a better future for their community

Level B1–C2  
Age 13–16 years  
Time 45–60 minutes

### Preparation

- You will need sticky notes/Post-its and the following video on sustainability:  
<https://www.youtube.com/watch?v=fcDDUSubq9A>
- Also, depending on the context where you teach, you should decide on and bring to class materials your students could use to create their improved public places, e.g. coloured paper, canvas paper, construction paper, cardboard, foam, etc
- Get students to take some pictures of public spaces in their neighbourhood

### Procedure

- Hand out sticky notes to your students, then show them the video. While watching, ask them to write down one benefit of sustainable development on their Post-it
- Ask students to show you the pictures they've taken and encourage them to choose the ones they feel are the least 'eco-friendly'. Ask them why they think so. Write down their comments on the whiteboard, e.g. no green spaces, lots of traffic, etc
- After this, group students with similar pictures together. Tell them that you would like them to redesign these places with the aim of improving them in relation to the main problem they are facing

- Provide them with a variety of ways/materials to work with, e.g. construction paper, canvas paper, cardboard or foam. Allow 15 minutes for this
- Each group then presents its creations to the rest of the class

### Follow-up

- Ask students to write reports or journal entries explaining how the activities you've worked on have helped them to learn more about environmental issues in general

### Additional resources

Planitgreenlive – Game on sustainability

- This is a game which allows you to build your own city and make green improvements to it:  
<http://www.planitgreenlive.com/>

Education Minecraft – Using Minecraft to build sustainable worlds

- The Minecraft game's education version has very helpful suggestions for ways to raise students' awareness of environmental issues:  
<https://education.minecraft.net/>

# 15

## Sustainable Development Goal 14: Conserve and sustainably use the oceans, seas and marine resources for sustainable development

Jill Hadfield and Charlie Hadfield

### Introduction

The activities in this chapter have been grouped into three themes:

- issues facing the oceans and marine life
- overfishing
- pollution and climate change.

The approach used in activity design is to begin with input, analysis and discussion to raise awareness of an issue facing the ocean, and then to provide stimulus for a creative response to the problem. There is also an introduction aimed at creating a positive vision of the ocean and recognition of its importance and a finale with activities aimed at suggesting problem-solving ways forward and a vision for the future.

The activities thus provide a balance of four areas: cognition – discussion and analysis of problems facing the oceans; affect – a positive vision of and feelings towards the oceans and the life they contain; creativity – creative expression in various genres of writing; practicality – problem-solving ways forward. This combination of cognition, affect, creativity and practicality provides multiple perspectives on the topic, which will increase understanding and encourage richness of response. It also enhances language use by encouraging varied forms of expression. Research on activities involving affect and creativity has shown that such activities encourage learners to engage more deeply with the subject matter and produce richer language.

The activities are most suitable for secondary school or adult students. The activities could form an overall long-term project, but are carefully designed so that any of the three topics within the project are self-standing, and any single activity can be done as a one-off activity, thus giving teachers maximum flexibility.

If activities are done as a project, the project could culminate with a collection of work. The finished products can be grouped together to make a display, booklet, magazine or webzine with two practical aims:

- awareness-raising – the collected work could be made public, for example a library display, to raise awareness of marine issues
- fundraising – the products could also be used to raise money for charities for ocean conservation, for example by selling a magazine or by charging a small admission fee or donation for viewing a display.

### Activity 1: Octopus poem

#### Aim

- For students to be able to write a poem in the shape of an octopus celebrating the sea

#### Language focus

- To develop students' abilities to use adjectives and –ing forms and vocabulary for oceans and marine life

#### SDG focus

- To raise awareness of the value of the ocean and celebrate its beauty and diversity

#### Creative focus

- Poetry writing: pattern poem, using language to create mood

Level Pre-intermediate – Intermediate

Age 12+

Time 30–40 minutes

#### Preparation

- Find some inspiring images of the sea in different moods – both above- and underwater:
  - o <https://www.flickr.com/photos/eltpics/sets/72157646290835526>
  - o <http://www.theoceanagency.org/50reefs/>
- Find the Beatles' 'Octopus's Garden' if you would like to use it: <https://youtu.be/c0vFUxE3SrM>

- Print an outline of an octopus for each student. One can be found at: <https://nz.pinterest.com/pin/325455510546799260/>.

### Procedure

- You can introduce the activity by playing the song 'Octopus's Garden'.
- Show the students a variety of pictures of the ocean in various moods – calm, sunny, stormy, etc.
- Brainstorm with the students nouns (e.g. waves, ripples, foam), adjectives (e.g. sparkling, shining, tranquil) and write them up on the board. Then show underwater pictures, e.g. shoals of fish, coral reef, seaweed, etc.
- Brainstorm nouns (e.g. shoals of fish, coral, seaweed, seagrass, anemones, etc.) and adjectives (e.g. mysterious, colourful, beautiful, etc.).
- Ask the students to work individually or in pairs.
- Give out the octopus outlines.
- Introduce this pattern for the students to write in:

#### First three tentacles: above water

Line 1: adjective noun adjective noun

Line 2: adjective and adjective

Line 3: adjective noun

#### Middle two tentacles: transition

Dive down

To a different world

#### Last three tentacles: underwater

Adjective noun adjective noun

Adjective and adjective

Adjective noun

- Get them to write their lines in the tentacles, using words from the board to inspire them.

### Example

Sparkling water, white waves

Vast and inspiring

Blue ocean

Dive down

To a different world

Waving grasses, colourful fish

Mysterious and surprising

Dark depths

- Get students to cut out the octopuses and display them in the class.

## Activity 2: Autobiographies from the garbage patch

### Aim

- To enable students to write autobiographies of items in the Pacific garbage patch

### Language focus

- Using past simple/past passive, sequencing, vocabulary for marine animals

### SDG focus

- For students to understand how people pollute the ocean

### Creative focus

- To enable students to develop their autobiographical writing skills

Level Pre-intermediate – Intermediate  
(if past passive is included)

Age 12+

Time 60 minutes

### Preparation

- Find an image or YouTube video of the Great Pacific Garbage Patch: <https://youtu.be/1qT-rOXB6NI>
- Pictures of animals affected by rubbish:
  - o [http://blog.oceanconservancy.org/wp-content/uploads/2015/12/seal\\_plasticNose-copy\\_blog.jpg](http://blog.oceanconservancy.org/wp-content/uploads/2015/12/seal_plasticNose-copy_blog.jpg)
  - o [http://www-tc.pbs.org/odyssey/images/20020206\\_daily\\_b.jpg](http://www-tc.pbs.org/odyssey/images/20020206_daily_b.jpg)
  - o <https://pbs.twimg.com/media/CB6pPz2UgAAEalz.png>

- o <https://s-media-cache-ak0.pinimg.com/236x/88/02/8f/88028f0f478279e3b63aa72db9522ff0.jpg>
- Find and print a Creative Commons picture of the Garbage Patch to use for posters: <http://www.photosforclass.com/search/great%20pacific%20garbage%20patch>.
- Make copies of the gap-fill text from the Materials section.

## Procedure

- Show the students a map of the US. Focus on Texas. Establish the size of Texas relative to their countries. It is bigger than France or Germany, for example. (A useful website is: <http://www.texasmonthly.com/the-daily-post/how-big-is-texas-compared-to-other-land-masses/>.)
- Tell students that there is an island of rubbish as big as Texas in the Pacific and show them the image or video of the Pacific Garbage Patch. Discuss their reactions to this.
- Ask them to discuss in pairs how long they estimate it takes for the following objects to biodegrade: plastic bags, foam cups, cans, plastic bottles, fishing nets, glass bottles. Collect guestimates and then tell them the answers.

### Answers

Plastic bags: 10–20 years

Foam cups and tin cans: 50 years

Aluminium cans: at least 80 years

Plastic bottles: 450 years

Fishing nets: at least 600 years

Glass bottles: 1 million years

A useful infographic can be found at:

<http://oceancrusaders.org/wp-content/uploads/2015/09/How-Long.jpg>

- Then ask students to discuss in pairs how they think this rubbish affects marine life. Collect answers and show some pictures.
- Ask for reactions to and feelings about the pictures.
- Animals such as seals, dolphins and seabirds can become entangled in nets or six-pack rings. Whales, dolphins, seals and turtles mistake plastic bags for jellyfish and eat them, which causes them to die. Seabirds and other animals can die from eating other plastic items which they mistake for food. Tin cans can injure animals or can be mistaken for food and cause death.
- Look again at the Garbage Patch picture and brainstorm with the students what could be in the rubbish island.
- Ask for ideas of how one of those objects might have come to be in the rubbish island, e.g.
  - o where it came from: country.
  - o who it came from: its owner.
  - o its 'life' before becoming marine litter.
  - o the incident that sent it into the ocean.
  - o incidents that occurred in the ocean.
- Put the students in pairs, then choose one object and discuss its 'autobiography'.

### Autobiography of a swimming costume

I am a swimming costume. I was made in a factory in China and sent to England to a big shop in London. A little girl, Zoe, came to the shop with her mother. They were looking for holiday clothes before going to California. Near San Diego, there are many lovely beaches. The family went swimming every day and Zoe learned to swim there, so she was very happy swimming with me. One afternoon she finished swimming, changed into her ordinary clothes, but forgot about me and left me on the sand! A big wave came and dragged me out into the ocean. I have been floating around in the Pacific Ocean for three years now! I wonder if Zoe remembers me sometimes?

- Ask them to write the autobiography with a sad ending, for example a seal gets entangled in the straps of a swimming costume, a turtle eats a balloon thinking it is a fish, etc.
- Brainstorm with the students some ideas for cleaning up the oceans and saving animals.
- Then ask learners to exchange autobiographies and to rewrite the ending to make it happier, for example the seal is found by an animal rescue organisation, the balloon drifts onto a beach before it is eaten and gets cleaned up by a beach cleaning party.
- The end product of this activity could be a class display of an enlarged photo of the Garbage Patch with the autobiographies around it, each connected by string to a piece of rubbish in the picture.

### Activity 3: If you go down to the sea today

#### Aim

- To enable students to write a poem about how to keep beaches clean

#### Language focus

- To develop students' abilities to use imperatives: Don't, Do, Remember, Make sure

#### SDG focus

- To raise awareness of how beaches become polluted

#### Creative focus

- To develop students' poetry writing; using rhythm and rhyme for impact

Level A2+

Age 12+

Time 30–40 minutes

#### Preparation

- Find an image or video of beaches littered with rubbish that people have left.
- Make copies of the poem template in the Materials section for each student.

#### Procedure

- Show the students a variety of pictures of polluted beaches.
- Discuss with them how the pollution got there, e.g. people leaving litter from picnics, and discuss the effects of the litter – for example, plastic can be poisonous if eaten by marine animals, the rings from six-packs can strangle marine animals.
- Brainstorm with the students a list of rules for beach users, using imperatives such as 'Don't ...', 'Do remember to ...', 'Don't forget to ...', 'Make sure ...', etc. For example, 'Don't throw your plastic bags away', 'Take your bottles home'.
- Put students in pairs and give them a copy of the poem template.
- Ask students to work together to fill in the missing lines, using ideas from the brainstorm on the board.
- Get students to read their poems out and/or display them in the classroom together with pictures of both polluted and pristine beaches.

### Materials

#### If you go down to the sea today

Don't let your litter stay

---

If you go down to the sea today

---

Take everything away

---

If you go down to the sea today

---

And have a lovely day!

### Activity 4: Dolphin dive

#### Aim

- To enable students to write a concrete poem in the shape of a dolphin

#### Language focus

- To enable students to use adjectives for reactions and feelings

#### SDG focus

- To raise awareness of how marine life suffers through overfishing

#### Creative focus

- To create shape poems, selecting adjectives carefully

Level A2+

Age 12+

Time 40–60 minutes

#### Preparation

- Find a video of dolphins leaping.
- Find an image or video of fishing nets catching dolphins.
- Make copies of a dolphin template for groups of three or four students: <https://s-media-cache-ak0.pinimg.com/236x/25/63/e7/2563e76f5df4336427e17ea2e7468249.jpg>.
- Make copies of the short text in Materials for each student.



## Procedure

- Show the students the pictures/videos and ask them what is happening in each case.
- Tell them how overfishing is causing dolphin deaths in three ways, or give them the short passage in the Materials section to read.
- Show the videos again and after each ask for reactions in the form of single words, e.g. beautiful, inspiring, tragic, cruel. Write the words on the board in two groups.
- Divide the class into two groups, A and B. Within each group create smaller groups of three or four.
- Ask Groups A to think about the first video and Groups B to think about the second.
- They should brainstorm as many more words and phrases as possible to describe the videos.
- Then give the groups a dolphin template and ask them to write the words in the shape, fitting them in closely so that the words form the shape.
- Get the groups to cut out their dolphins.
- Display the dolphins, rotating the shapes so that the positive dolphins are leaping up and the negative dolphins are nose-diving.

## Materials

Fishermen are catching too many fish, which means that many dolphins are starving.

Dolphins are often found with shoals of tuna, which means that fishermen hunt for tuna and catch dolphins along with the tuna. Seven million dolphins have been killed in this way.

Dolphins are killed for food in some parts of the world.

## Activity 5: The fish's lament

### Aim

- To enable students to write a speech on overfishing from the fish's point of view

### Language focus

- To enable students to use imperatives, present tenses and modals

### SDG focus

- To raise students' awareness of overfishing

## Creative focus

- To enable students to write a speech using language to persuade

Level B1+

Age 12+

Time 60–90 minutes

## Preparation

- Background reading: <https://www.newscientist.com/article/2106331-fish-recorded-singing-dawn-chorus-on-reefs-just-like-birds/>
- Find a video of fish singing: <https://www.youtube.com/watch?v=6HhwFa1cDbc>
- Copy the role cards in the Materials section.

## Procedure

- Ask the students to brainstorm answers to the following questions:
  1. What is overfishing?
  2. Why is overfishing a problem?
  3. What can I do to help?
- Discuss their answers:
  1. Overfishing is simply catching so many fish that not enough adult fish can remain to breed and sustain the population. Worldwide, fishing fleets are two to three times as large as needed.
  2. Over 80 per cent of the world's fisheries are overfishing. We are losing species of fish as well as ecosystems. We are at risk of losing a food source.
  3. There need to be limits on the numbers of fish caught.
- Tell the students that fish have been recorded communicating with each other and play the recording of fish communication.
- Give students the role cards from Materials and ask them to make notes on a speech they might give to the UN.
- Put students in pairs and ask them to compare notes and add ideas.
- Then have a UN debate: half the students (one in each pair) give their speeches. The rest are the UN council who listen, make notes and then give their opinions and come to a resolution on what action to take.

## Materials

### Role card

You are one of the last fish in one of the last shoals of fish in your part of the ocean. You are their United Nations representative. All your relatives, and many of the other kinds of fish who were your friends and neighbours, have gone – they have disappeared for ever, either fished up by the huge trawl nets or long lines dragged by the ever bigger fishing boats from all over the Earth or, if they were lucky to escape with their lives, they have migrated as refugees to the temporary safety of a strange sea or ocean. You are very worried for the future of your immediate family and relatives, the only fish left here.

## Activity 6: Adrift!

### Aim

- To enable students to write a story describing how a polar bear came to be adrift on an ice floe

### Language focus

- To enable students to use narrative tenses: past simple, past continuous, past perfect; adjectives for feelings

### SDG focus

- Developing students' understanding of climate change and polar ice melt

### Creative focus

- To develop a story, combining narrative and description

Level B2+

Age 12+

Time 40–60 minutes

### Preparation

- Find an image of a polar bear adrift on an ice floe.

### Procedure

- Show students the pictures of the stranded polar bears and ask for reactions.
- Introduce some of the key vocabulary: North Pole, polar bear, ice cap, melt, ice floe, seals, stranded.
- Discuss with the students the cause of the ice melt (climate change).

- Get them to brainstorm what some of the consequences for wildlife might be. Discuss these and add any from the list below.

### Consequences:

- o The bears often face long exhausting swims back to the ice cap.
  - o Cubs are unable to swim long distances, so may die.
  - o Sometimes the bears get stranded on land where they have nothing to eat.
  - o The melting of the ice cap has meant that killer whales come and eat the seals which are the bears' source of food.
  - o There is a decline in the numbers of bears.
- Ask the students to write a short story about the bear's experience – from the bear's point of view.
  - Prepare for this with a visualisation. Ask students to close their eyes and imagine a polar bear stranded on an ice floe. Allow a few seconds for them to get the image clear in their minds, then continue with questions, leaving enough time between questions for them to visualise the next stage in the story:
    - o Imagine you are the bear ... How did you get stranded? ... Are you alone?
    - o How do you feel? ... What are you going to do? ... How do you get back to the ice cap – or do you end up on land? ... What adventures do you have on the way?
  - Then ask students to open their eyes and work with a partner to tell their stories.
  - Finally, get them to write their story.
  - The stories can be made into a booklet or displayed on the wall with pictures.

## Activity 7: I have a dream

### Aim

- To enable students to create their dream for the future of the oceans based on the famous speech

### Language focus

- To develop students' abilities to use 'will' to talk about the future

## SDG focus

- To enable students to see a vision for the future of oceans

## Creative focus

- To enable students to write a speech using repetition and patterning for rhetorical effect

Level A2+

Age 12+

Time 40–50 minutes

## Preparation

- Find the text and video of Martin Luther King's speech.
- Make copies of the simplified speech in the Materials section.
- Make copies of the speech template in the Materials section for each student.

## Procedure

- Remind the students of the work they have done so far on the problems facing the oceans – pollution, overfishing, climate change – and of any solutions they have suggested, e.g. fines on polluters, stricter regulation on fisheries, green energy, etc. Divide students into three groups: overfishing, pollution and climate change.
- Set them a task, either in class, with access to computers or mobile phones, or for homework. They should research the question: What can people do to solve this problem? They should try to find practical ways the following can help: governments, the UN, corporations, charities and volunteers, individuals like themselves.
- Put students into threes, with one student from each of the three original groups, to share ideas for solutions.
- Teach the words: nation, creed, slave, brotherhood, oasis, freedom, justice, character. Then let them listen to and read the 'I have a dream' section of Martin Luther King's speech (web references above). Use the simplified speech in the Materials section if you think they need it.
- Discuss the speech with the students – has the dream come true?
- Put students in groups of three or four and give each group a large sheet of paper.

- Ask them to brainstorm their dreams for the ocean under the topic headings:
  - o fish, marine animals (seals, dolphins, turtles), sea birds, beaches, coral reefs, polar animals, people (hit by cyclones or living in low-lying coastal areas).
- Now give each group the speech template from the Materials section.
- Ask them to choose their five best ideas and write them into the speech template.
- Ask groups to practise giving the speech.
- Now regroup the students so that each new group contains one member from each of the original groups.
- Get them to give their speeches.

## Materials

Simplified script:

And so even though we face the difficulties of today and tomorrow, I still have a dream.

I have a dream that one day this nation will rise up and live out the true meaning of its creed: 'All men are created equal.'

I have a dream that one day on the red hills of Georgia, the sons of former slaves and the sons of former slave owners will be able to sit down together at the table of brotherhood.

I have a dream that one day even the state of Mississippi will be transformed into an oasis of freedom and justice.

I have a dream that my four little children will one day live in a nation where they will not be judged by the colour of their skin but by the content of their character.

I have a dream today!

I have a dream that one day, down in Alabama, one day right there in Alabama, little black boys and black girls will be able to join hands with little white boys and white girls as sisters and brothers.

I have a dream today!

## Speech template

And so even though we face the difficulties of today and tomorrow, I still have a dream.

I have a dream that one day

I have a dream that one day

I have a dream that one day

I have a dream that

I have a dream today!

I have a dream that one day

I have a dream today!

# 16

## Sustainable Development Goal 15: Protect, restore and promote sustainable use of terrestrial ecosystems, sustainably manage forests, combat desertification, and halt and reverse land degradation and halt biodiversity loss

Chrysa Papalazarou

### Introduction

In the beginning of the 21st century we are constantly reminded that life on land is in grave danger. Terrestrial ecosystems falter, forests are rapidly disappearing, desertification is spreading, biodiversity is diminished. The multitude of treaties, organisations, foundations, alliances, charities and campaigns all attest to the complexity of the issue and the need for awareness and action.

At present an estimated 13 million hectares of forests are being lost every year, while the persistent degradation of dry lands has led to the desertification of 3.6 billion hectares. The UN Sustainable Development Goal (SDG) 15 focuses on achievable goals that can help to redress the problem of increasing deforestation.

The aim of this chapter is to provide some ideas on how we can approach creatively in the English classroom the issue of deforestation. This involves the use of visual stimuli, street art, painting, photography and video. These inputs call for students to explore poetry writing, to observe carefully, to think critically, to understand the heart of the issue and synthesise new information imaginatively. They also aim at fostering a global attitude – curiosity, knowledge, understanding, global awareness, respect and an appreciation of the world's precious natural surroundings.

### Activity 1: Words and forests

#### Aim

- The aim of this activity is to discuss the value of forests and encourage students to write concrete poems.

#### Language focus

- Students learn forest-related vocabulary.
- They practise writing sentences about the importance of forests.
- They practise writing visual poems.

#### SDG focus

- SDG 15: Life on land – The activity links to an important element of this Goal: the value of forests for life on Earth.

#### Creative focus

- Students explore creatively different writing styles by writing concrete poems on the value of forests.

Level A2+

Age 12 years old and older

Time 60 minutes

#### Preparation

- You will need internet access to show this Tagxedo word cloud on the value of forests or you can download it prior to the lesson: <https://www.slideshare.net/secret/kAVry5IGFkCwT>.

#### Procedure

- Write this sentence on the board and brainstorm a few ideas with the students:  
'Forests are important/valuable because they ...'
- Show students the Tagxedo on the value of forests.

- Ask them to read individual words or phrases and take notes.
- Help them deal with new vocabulary.
- Give students the worksheet on the importance of forests (see Materials). Ask them to form sentences on the value of forests. For example: 'Forests provide homes for people and animals.'

Do this as a speaking activity first before asking students to write their sentences on the worksheet. Then collect their sentences and give feedback.

- Write on the board: 'concrete poem'.
- Explain that this kind of poem has a shape that matches the topic it deals with. It is also called a visual poem. The shape the words make is as important as what it says. In this case the shape of the poem would be a tree.
- You can show them some examples of concrete poetry to help them get an idea of the visual element: <http://saladogt.pbworks.com/w/page/45052568/Concrete%20Poems>.

- Ask the students to reflect on the previous stage about the value of forests. Then, ask them to write their own poem on the topic. They first write it in their notebooks, without putting it into shape. They can write freely and let their imagination run. The poem does not have to rhyme. They also need not worry about the length of their poem, but remind them that the more words they have, the bigger their shape will be.
- When they finish their poems, they can draw the outline of a tree on a piece of paper and match the words to the shape.
- Remind students that the words of the poem are important, too. They can experiment with letter size, mix lower- and upper-case letters or add colour.
- Post the visual poems in the classroom for everyone to see and read.

### Follow-up

- Students can write more visual poems at home practising the forest-related vocabulary they learned.

## Materials

### Worksheet: Forests are important because ...

Match the verbs on the left with the words and phrases on the right to write sentences about the value of forests. (Notice: multiple options are possible.)

block	air
clean	noise
control	water
fight	shade
give	temperature
offer	wildlife
produce	oxygen
protect	biodiversity
provide	floods
reduce	food
	timber
	medicine
	homes for people and wildlife
	carbon dioxide

## Additional resources

Poetry Beyond Text: Vision, Text + Cognition – Concrete Poetry

- This post explores the genre of concrete poetry: <http://www.poetrybeyondtext.org/concrete-poetry.html>

Ken Nesbitt's poetry4kids – how to write concrete poetry

- This post describes the what and how of concrete poetry writing: <http://www.poetry4kids.com/news/how-to-write-a-concrete-poem/>

## Activity 2: Killing ourselves

### Aim

- The aim of this activity is to have students observe, think about and respond to the issue of deforestation prompted by an intriguing piece of street art.

### Language focus

- Students practise present simple and present continuous.
- They practise expressing their opinion by using 'I think'.
- They practise asking questions.

### SDG focus

- SDG15: Life on Land – The activity links to the issue of deforestation caused by human activity.

### Creative focus

- Exposure to and careful observation of street art combined with the use of the see-think-wonder routine arouses students' imagination and curiosity (See Additional resources for information about this routine).
- Aroused curiosity results in higher motivation levels and openness to learning, which allow for interesting and original observations, thoughts and questions.

Level A2+  
Age 12+  
Time 60 minutes

### Preparation

- You need to have an internet connection to project the street art piece in class: <http://tinyurl.com/zhz75h9>.

### Procedure

- Ask students if there are forests in their town/city/area/country. Then ask them if they visit them alone/with family/friends. Ask how often they visit them, why and if they like it.
- Show students this image of street art by Santiago Pejac: <http://tinyurl.com/zhz75h9>.
- Ask them to observe it quietly and carefully for a couple of minutes and reflect on the three prompts:
  - o What do you see?
  - o What do you think about it?
  - o What does it make you wonder?
- Allow for some quiet observation time. Students can first jot down their responses before sharing them with the rest of the class. They can work individually, in pairs or in small groups.
- Ask students to present and share their responses with the rest of the class.
- Document their thinking and ideas. You can do this by using the board. You can also hand out sticky notes to the students and ask them to write their responses there. Then, post the sticky notes on the classroom walls so that everyone can see and read them.
- Ask students questions like:
  - o Where do you think you can find this piece of art?
  - o Why do you think the artist made it?
  - o How does it make you feel?
  - o What do you think the message is?
  - o Can you think of a title?
- Reveal that it is a street art piece and the title is 'Killing Ourselves'.
- Write the name of the artist and the title on the board. Explain that street art uses simple slogans and provocative images to spread important and inspiring ideas in ways that are easy to remember. Such art can inspire people to action or at least remind them about important issues.
- Write the word 'deforestation' on the board if it has not come up during the discussion. Provide the following definition by Cambridge English Dictionary: 'The cutting down of trees in a large area, or the destruction of forests by people.'

## Follow-up

- Invent a slogan to accompany the street art piece. Explain that a slogan is a short, memorable phrase to express an idea or a purpose and persuade people.
- Research other definitions of deforestation that add more information to the issue.
- Write a short text reflecting on the lesson. Organise the writing in paragraphs:

Paragraph 1: What we saw – describe the street art piece.

Paragraph 2: See-think-wonder – describe what we did – select from the ideas shared in class those that were important for you – write them – feelings – impressions – why?

Paragraph 3: Deforestation – what is it?

## Additional resources

Art least – See-Think-Wonder

- This blog post provides classroom examples of the see-think-wonder thinking routine: <https://chrysapalazarou.wordpress.com/2015/06/05/see-think-wonder-the-impact-of-curiosity-on-learning/>

Visible Thinking – See Think Wonder

- This page is about the rationale behind the see-think-wonder thinking routine: [http://www.visiblethinkingpz.org/VisibleThinking\\_html\\_files/03\\_ThinkingRoutines/03c\\_Core\\_routines/SeeThinkWonder/SeeThinkWonder\\_Routine.html](http://www.visiblethinkingpz.org/VisibleThinking_html_files/03_ThinkingRoutines/03c_Core_routines/SeeThinkWonder/SeeThinkWonder_Routine.html)

## Activity 3: Rainforest of my mind

### Aim

- The aim of this activity is to familiarise students with wildlife diversity found in the rainforest and foster their appreciation of it.

## Language focus

- Students learn to recognise, name, describe, talk and write about rainforest animals.
- They play the ‘I spy’ game to expand vocabulary.

## SDG focus

- SDG 15: Life on land – This activity focuses on the habitat rainforests provide for a large number of the world’s animal species, including many endangered species. As forests are cut down, these species are doomed to extinction. Students learn about some of the animals of the rainforest, their beauty and their value for life on Earth.

## Creative focus

- Students observe paintings and photos of rainforest animals.
- The ‘I spy’ game helps them develop their powers of perception and observation, and have fun.
- Individual and collective creative expression is encouraged by making a collage of their own rainforest.

Level A1+

Age 10–12 years old

Time 90 minutes

## Preparation

- You need internet access for the following materials:
  - o rainforest animals  
<https://www.slideshare.net/secret/8dn94k7mr7rB9>
  - o map  
[https://upload.wikimedia.org/wikipedia/commons/8/8d/Rain\\_forest\\_location\\_map.png](https://upload.wikimedia.org/wikipedia/commons/8/8d/Rain_forest_location_map.png)
  - o rainforest animal guide  
[https://www.scribd.com/document/328843379/Deep-in-the-Heart-of-the-Rainforest?secret\\_password=3Lbxd9diayOT9gglcWi](https://www.scribd.com/document/328843379/Deep-in-the-Heart-of-the-Rainforest?secret_password=3Lbxd9diayOT9gglcWi)
  - o the Rainforest stop-motion animation  
<https://vimeo.com/40393225>



## Procedure

- Write the following words on the board and ask students to copy them in their notebooks: caiman, kinkajou, toucan, sloth, ocelot, okapi, lemur, tapir, tarsier.
- Ask individual students to read them.
- Ask students if they are familiar with any of these animals and to guess what these words might be about.
- Add some more words: anaconda, fruit bat, jaguar, howler monkey, red-eyed tree frog, tarantula, orang-utan, green iguana, owl.
- Elicit that they are all animals.
- Write on the board: Rainforest animals.
- Show students the first slide of the 'Rainforest animals' slide show. Ask them to observe the paintings and photos quietly for a few minutes.
- Ask questions like:
  - o What can you see?
  - o What colours can you see?
  - o Can you name any of the animals?
- Ask students if they know what a rainforest is.
- Provide the following definition by the Cambridge English Dictionary: 'A forest in a tropical area that receives a lot of rain.'
- Ask students if they know where such forests can be found.
- Show them the map: [https://upload.wikimedia.org/wikipedia/commons/8/8d/Rain\\_forest\\_location\\_map.png](https://upload.wikimedia.org/wikipedia/commons/8/8d/Rain_forest_location_map.png) and point out the places in the world with rainforests.
- Write them on the board: Central and South America, Africa, South East Asia, Australia.
- Explain that rainforests cover only a small part of the Earth's surface – about 6 per cent – yet they are home to over 50 per cent of the species of plants and animals in the world. They are very important, but they are disappearing very fast.
- Hand out the rainforest animal guide with information about some of the rainforest animals. Go through it with the students, ask individual students to read and deal with new vocabulary.
- Show students the slide show again. Go through the slides and ask students questions about each animal based on the information in the animal guide. Give them time to focus and observe details in each slide.
- Show the first slide again. Play the 'I spy' game. Use the information from the leaflet and ask them to spot and name a specific animal in the slide. Start by saying: 'Deep in the heart of the rainforest, I spy with my little eye ...' (an example: 'an animal that lives near the water and belongs to the crocodylian family – caiman'). If any students feel confident enough, let them lead the game.
- Point to specific animals. Give the right name, but wrong information. Ask students to correct you.
- Show students the Rainforest stop-motion animation.
- Show it for a second time. Pause and ask questions about the animals in the video. Draw students' attention to the way the children have drawn the animals that appear in the video.
- Ask students to choose a rainforest animal and draw it. They don't have to use the exact colours the animal has. They can let their imagination run. They can also write some sentences about this animal on their drawing. Post students' work on the classroom wall.

### Follow-up

- As a homework activity ask students to fill in the crossword puzzle on the rainforest animals. This lesson may continue as an ongoing class project.

## Deep in the heart of the rainforest puzzle

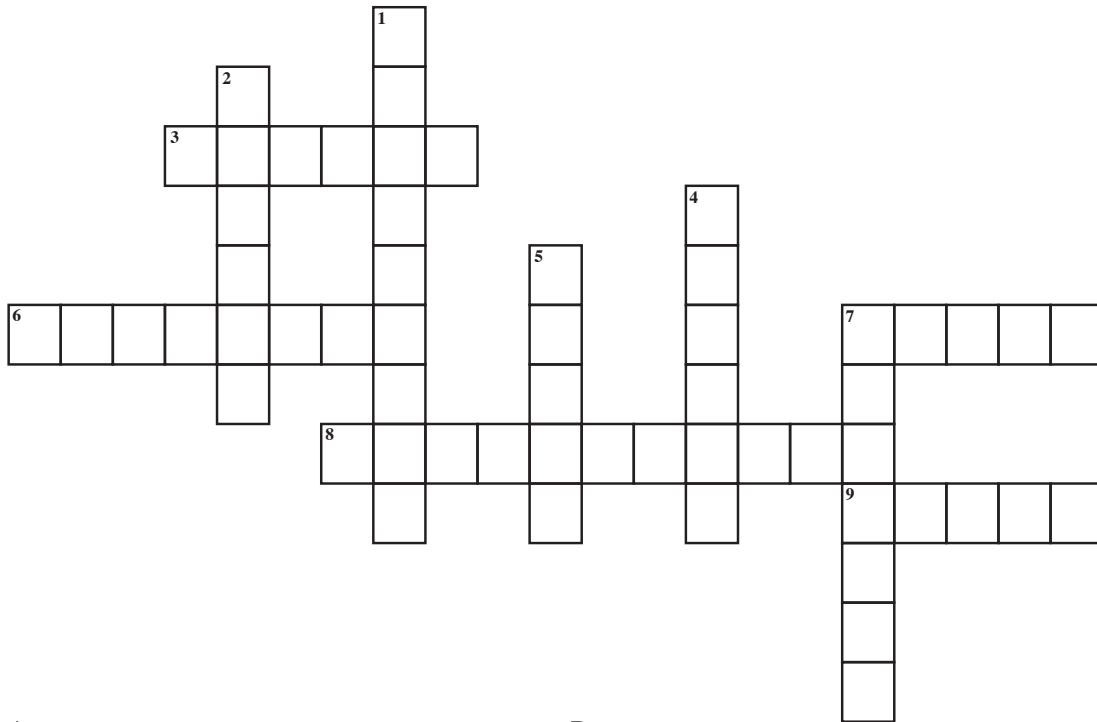

#### Across

- A medium-sized corcodilian from Central America and South America.
- It belongs to the racoon family and it likes fruit.
- It lives in central and South America and looks like a pig. It is an engangered animal.
- The part of the rainforest where plants and animals live. (two words)
- A very slow animal hanging upside-down from tree branches.

#### Down

- It eats tropical fruit, leaves, and insects. It lives on the islands of Borneo and Sumatra in Indonesia.
- A large, spotted wild cat from South and Central America.
- It has a big, colourful beak.
- It lives in Central Africa and has stripes on its legs.
- A nocturnal mammal with enormous eyes that lives on trees.

- Students can search the internet for more rainforest animals or even plants, bring photos or draw, write short captions and expand the classroom collage.

## Additional resources

National Geographic: Photo Gallery

- This gallery contains photos of some of the rainforest animals and relevant information: [http://environment.nationalgeographic.com/environment/photos/rainforest-tropical-wildlife/#/scarlet-macaw\\_369\\_600x450.jpg](http://environment.nationalgeographic.com/environment/photos/rainforest-tropical-wildlife/#/scarlet-macaw_369_600x450.jpg)

## Activity 4: Palm oil message in a bottle

### Aim

- The aim of this activity is to raise awareness of the role of palm oil in deforestation.

### Language focus

- Exploring vocabulary related to palm oil and the environment
- Reading with a focus on finding out what appeals to the students
- Summing up and capturing the essence of the topic
- Synthesising verbally and non-verbally the information learned

### SDG focus

- SDG15: Life on Land – The extensive use of palm oil in over 50 per cent of everyday products leads to rapid rainforest destruction and wildlife degradation.

### Creative focus

- The phrase-word activity helps students engage meaningfully in reading with a focus on finding out what appeals to them. Personal choice can generate interesting ideas and lead to rich discussions.
- The headlines activity helps them sum up and capture the essence of the topic.
- The creation of a poster on palm oil and its relation to deforestation promotes students' organisational and creative skills as they are called to synthesise the information they got through reading, watching and discussing.

Level A2+  
Age 12 years old and older  
Time 90 minutes

## Preparation

- Teachers need internet access to project the following links:
  - o Protect Paradise: An animation about Palm Oil: <https://www.youtube.com/watch?v=0o6WHN4NDTk>
  - o Sustainable palm oil symbols slide: <http://www.slideshare.net/secret/8UKcF4jTOvca8c>

## Procedure

- Write the following words on the board and ask students to copy them in their notebooks:  
shampoo, soap, lipstick, detergent, potato chips, margarine, cereal, ice cream, instant noodles, cookies, pizza dough, packaged bread, biodiesel.
- Ask them to guess what these words might have in common.
- Brainstorm ideas.
- Pass out Worksheet 1: Newspaper headlines (see Materials). Give students a few minutes to read and think about the meaning of each headline. They can look at the glossary to guide themselves through. Go round the class and provide help if needed.
- Ask students what word keeps repeating in all the headlines.
- Give students the following pairs of words:
  - o Palm oil – environment
  - o Palm oil – rainforest
  - o Palm oil – orang-utans
  - o Unsustainable palm oil – endangered species.
- Ask them to look at the headlines again and form sentences of their own using these pairs.
- Collect their sentences and give feedback.
- Ask students to work individually, in pairs or in groups. It depends on how many ideas you want to generate. Tell them to read the headlines again. While reading they will have to choose:
  - o a phrase that moved or engaged them
  - o a word that captured their attention or struck them as powerful.
- They can first take notes of their selections and the reason behind them before sharing them with the rest of the class. Go round the class and help with vocabulary if needed.

- Allow 15–20 minutes and get feedback. Students can present and share their selections of phrases/words. Sharing can be done a) in pairs or small groups and/or b) in the form of a plenary discussion. Use the board to record their choices so that everyone can see and comment on them.
- After sharing, invite students to reflect on the discussion and identify common themes that have emerged from their responses.
- If possible, post all answers in the classroom and provide some time for students to think again about their classmates' phrases/words.
- Encourage the class to take notes of their classmates' responses and justifications. This will contribute to a better personal and collective understanding. They do not have to take notes of everything shared in class but prioritise what is essential for them. This further adds to their organisational and creativity skills.
- Tell students that they are going to watch a short animation about palm oil by Greenpeace: <https://youtu.be/0o6WHN4NDTk>. Before watching, hand out Worksheet 2: Video questions, and useful links (see Materials). Ask them to focus only on the first part of the worksheet and read the questions.
- Watch the video twice (or more times if needed).
- Get feedback on the questions.
- Write on the board: 'Sustainable palm oil'. Explain that it is palm oil produced in ways which respect people, forests and wildlife.
- Show them the slide with sustainable palm oil symbols.
- Ask them if they have noticed any of these on supermarket products. Ask them if they will look out for them in the future and why.
- Ask students to write their own headlines for the topic that summarise and capture a key aspect that they feel significant and important. They can experiment with letter size, mix lower- and upper-case letters or add colour.

## Materials

### Worksheet 1: News headlines

- Once a Dream Fuel, Palm Oil May Be an Eco-Nightmare
- Forest-destroying palm oil powers cars in EU: report
- Is Indonesia's fire crisis connected to the palm oil in our snack food?
- Indonesia forest fires: A third of world's wild orang-utans at risk in raging peat fires
- Palm oil: The worldwide movement to make it sustainable
- Rainforest is destroyed for palm oil plantations on Malaysia's island state of Sarawak
- Profitable palm oil leaves environment poor
- Cutting Deforestation Out Of Palm Oil
- Endangered species threatened by unsustainable palm oil production
- Malaysia rapidly destroying forests for palm oil
- Only sustainable palm oil

deforestation: The cutting down and removal of all or most of the trees in a forested area
destroy: ruin, spoil
eco: ecological, environmental
endangered species: threatened with extinction
nightmare: bad dream, terrifying thing
peat: organic material, compost, vegetable matter
plantation: cultivated land, farm
profitable: bringing in a lot of money
raging: spreading, moving violently
rapidly: very, very fast
sustainable: environmentally and socially friendly
unsustainable: causes damage to the environment and people

## Worksheet 2: Video questions

A. Read the following questions before watching the video and mark five of them to focus your attention on:

1. Where can you find palm oil?
2. What is the problem with palm oil?
3. Why are Indonesia's forests disappearing?
4. Why is Indonesia important for the environment?
5. How many of the world's animal, plant, bird species live in the Indonesian rainforests?
6. How many Sumatran tigers are left in the wild?
7. How are the lives of Indonesians changing?
8. Why are Indonesian peat lands important for the climate?
9. What happens when there are fires?
10. What is the road of palm oil before it gets to you?
11. What must companies do?

B. These links will help your research at home.

- <http://www.worldwildlife.org/pages/which-everyday-products-contain-palm-oil>: You can peel back the label and learn more about which products contain palm oil and why.
- <http://www.rainforest-alliance.org/articles/rainforest-alliance-certified-palm-oil>: You can read about the Rainforest Alliance Certified Palm Oil and how it protects people, forests and wildlife.
- <http://www.orangutan.org.uk/how-to-help/adopt-an-orangutan>: You can find out how to help by adopting an orang-utan.
- <http://www.palmoilandfood.eu/en/what-is-palm-oil>: You can read and find out more about what palm oil is.
- <https://www.msn.com/en-us/video/tunedin/how-do-i-use-palm-oil-responsibly/vi-BBwv79z>: You can watch a short video on how to use palm oil responsibly.

## Follow-up

- Ask students to use the links in the second part of the questions worksheet and research further on the palm oil issue at home, bring photos, write information, draw pictures. Use the headlines and the material brought by the students to create a classroom poster.
- Ask students to bring supermarket items like the ones highlighted in the beginning of the activity to class, and trace palm oil in the ingredients.
- More advanced students can practise writing letters to companies/supermarkets/restaurants/politicians, explaining their concern about the issue and asking for action to be taken. For sample letters, see link below (in Additional resources).

## Additional resources

PalmOilAction.org.au – Sample letters

- Examples of letters calling for action: <http://palmoilaction.org.au/resources/sample-letters/>

Rainforest Action Network – The human cost of conflict palm oil

- This is a short animation video on the human cost of conflict palm oil: <https://www.youtube.com/watch?v=BHreDVW0Fo>

WWF International – Palm oil: how our consumer choices affect wildlife

- A short video by WWF on the increasing demand for palm oil and the price paid by tropical forests and biodiversity: <https://www.youtube.com/watch?v=w-1DQwaaUwE>

## Activity 5: The Last Orangutans

This activity makes use of photos that belong to the photography project 'The Last Orangutans' by Sandra Hoyn, a German photojournalist. For each photo there is a corresponding question. With the exception of those in the last photo, the questions come from Alan Maley, Alan Duff and Françoise Grellet's book, *The Mind's Eye: Using pictures creatively in language learning*.

### Aim

- The aim of this activity is to raise awareness of the rapid decrease of orang-utan populations in the wild because of the critical loss of habitat caused by human activity, especially the unchecked burning of rainforests to clear land for palm oil plantations.

## Language focus

- Students respond orally and in writing on a number of visual stimuli.

## SDG focus

- SDG 15: Life on land – Biodiversity loss and extinction risks in South East Asia, mainly owing to the conversion of rainforests to palm oil plantations

## Creative focus

- Students observe, think and respond creatively to a number of questions.
- Exploring multiple perspectives, deepening students' understanding, and stimulating empathy

Level A2+

Age 12+ years

Time 60 minutes

## Preparation

- Teachers need internet access to project this slide show: <https://www.slideshare.net/secret/uw9YDUUnBqWpEHF>.

## Procedure

- Ask students if they know where orang-utans live. Show the first slide of The Last Orangutans slide show and read the introductory information.
- For each of the following five photos (slides 2–6) allow five or six minutes and then get feedback. Students can work individually, in pairs or in groups. Here follow the questions for each photo:
  - Photo 1:
    - o How do you feel when you look at this photo? Try to explain your feelings.
    - o The scene in this photo is calm. Imagine something happens that disturbs this calm atmosphere. What is it?
  - Photo 2:
    - o Imagine what is around this picture. Is it part of something larger?
    - o Imagine this photo appears in an environment magazine. What words or sentences go with it?
  - Photo 3:
    - o Imagine you are one of the persons in this photo. You are worried. Why? Write a few of the things you are worried about.
    - o You were there and saw what happened. There is a thought, a sentence, a question running through your mind. What is it? Write it down.

- Photo 4:
  - o Consider the following adjectives: frightening, annoying, disturbing, alarming, sad, cold. Which of these adjectives best describe your feelings towards this photo? Why? Try to explain your choice. Add other adjectives if you wish.
  - o Write a four-line poem to show your reaction to this photo. Use at least one of the adjectives listed above.

- Photo 5:

Ask students to step inside the image and imagine they are the orang-utan or one of the people in the photo. Make sure that there is an equal representation of these two perspectives in case students massively show a preference for one of them. From their chosen perspective they will have to answer the prompts:

What do you perceive/understand?

- o What do you believe?
- o What do you care about?
- Students first jot down their responses before sharing them with the rest of the class.

## Follow-up

- Ask students to elaborate more on their responses at home, write their thoughts, feelings, short poems or draw pictures. Post their work in the classroom for everyone to see and read.

## Further resources

AFP News Agency – Deforestation

- This is a useful video to explain deforestation to students: <https://www.youtube.com/watch?v=TX1RQ8nDESI>

Take part – The World's Vanishing Forests

- This is an interesting short video to familiarise students with the state of the world's forests: <http://www.takepart.com/video/2016/04/18/global-deforestation>

FAO – International Day of Forests 2014

- This is a short animation on the value of forests by the Food & Agriculture Organization of the United Nations: <https://www.youtube.com/watch?v=gnMgNt3122I>

Conservation International – I am the rainforest

- This is a beautiful and powerful video, narrated by Kevin Spacey, to get students to learn the value of rainforests: <http://www.conservation.org/nature-is-speaking/Pages/Kevin-Spacey-Is-the-Rainforest.aspx>

Mother Nature Network – 21 reasons why forests are important

- This is useful to get more advanced students reading about the importance of trees: <http://www.mnn.com/earth-matters/wilderness-resources/blogs/21-reasons-why-forests-are-important>

Forest Planet – Imag(in)ing a world without trees

- This is a blog post that has three GIF visuals to get students to talk and compare the before-and-after stage of three famous paintings where the trees are photoshopped out: <https://forestplanet.wordpress.com/2013/01/08/imagining-a-world-without-trees/>





# 17

## Sustainable Development Goal 16: Promote peaceful and inclusive societies for sustainable development, provide access to justice for all and build effective, accountable and inclusive institutions at all levels

Rebeca Duriga

### Introduction

Optimism about the future does not come easily to people, even famous ones. 'Perhaps two-thirds of the people of the earth will be killed ... in a war fought with the atomic bomb' predicted Albert Einstein. George Orwell painted an even darker picture of what he believed awaited mankind: 'If you want [to see] the future, imagine a boot stamping on a human face – for ever'. And HG Wells' Time Traveller 'thought but cheerlessly of the Advancement of Mankind, and saw in the growing pile of civilisations only a foolish heaping that must inevitably fall back upon and destroy its makers in the end' (The Time Machine, 1895).

Historically, pessimism has also enveloped ideas that were dismissed as ludicrous dreams before being turned into actual technological tools we can all enjoy today. Here are a few famously wrong predictions that have made some people sceptical of their own scepticism:

- 'This telephone has too many shortcomings to be seriously considered as a means of communication. The device is inherently of no value to us', said an 1876 Western Union internal memo.
- 'The abdomen, the chest, and the brain will forever be shut from the intrusion of the wise ... surgeon', declared Sir John Ericksen, Surgeon-Extraordinary to Queen Victoria.
- 'Heavier-than-air flying machines are impossible', claimed Lord Kelvin, President of the Royal Society, just eight years prior to the Wright brothers' first sustained heavier-than-air manned flight.
- 'Who ... wants to hear actors talk?' asked Warner Brothers' HM Warner towards the end of the Roaring Twenties.

- 'I think there is a world market for maybe five computers', asserted the chairman of IBM in 1943.

As for noble ideals such as peace, justice and strong institutions – United Nations Goal 16 – they have been deemed unrealisable too. At best, SDG 16 with its targets for 2030, including ensuring equal access to justice for all, reducing corruption, developing effective, accountable and transparent institutions, protecting fundamental freedoms, and promoting non-discriminatory laws and policies, are thought of by many as worthwhile goals to passively aspire to.

And yet, they are concrete aims which can be gradually met provided we all do our part. To this end, we can find inspiration in the actions of brave men and women who, despite surrounding pessimism, have done their fair share in contributing to a better future and laid a foundation for us to build on. The chapter will focus on a sample of such actions: one major historical event as well as two Nobel Peace Prize winners' accomplishments in relation primarily to SDG 16.

The activities are designed mostly for – though not limited to – the 14–17 age group. This rising generation should know that certain freedoms they enjoy today came at a cost, and knowing this may motivate them to work towards the peace, justice and strong institutions current and future generations need, through the help of schools, clubs, teams and specialised organisations.

A common thread that binds the activities is their threefold focus on project work (1), use of video (2) and acting (3) in the classroom, all of which have considerable advantages.

## Activity 1: The Zong

### Aims

- To bring history to life by showing a strong link between the past and the future we are trying to create
- To develop research, summary, writing and acting skills

### Language focus

- Functional language of introducing viewpoint, agreeing and disagreeing
- Trial-related vocabulary

### SDG focus

- The Zong case illustrates the importance of strong institutions and just treatment of human beings irrespective of race and so it directly relates to SDG 16.

### Creative focus

- The students' artistic re-enactment of the Zong trial will stimulate their creativity as they work on an original script and discover their screen persona.

Level B1+

Age 14+

Time 60–120 minutes

### Preparation

- Make one copy per six students of the Dido Elizabeth Belle painting: [https://en.wikipedia.org/wiki/Dido\\_Elizabeth\\_Belle#/media/File:Dido\\_Elizabeth\\_Belle.jpg](https://en.wikipedia.org/wiki/Dido_Elizabeth_Belle#/media/File:Dido_Elizabeth_Belle.jpg). Cut each picture into six pieces.
- You will need access to the Belle film trailer: <http://www.belle-themovie.com/#/media>.
- Make copies of Worksheets 1 and 2. See the Materials section.

### Procedure

- Distribute the broken-up puzzle pieces of the Belle picture to the groups – one set per group. Groups then reassemble the picture.
- Write the questions below on the board and ask each group of six students to split into two and discuss them:
  - o When do you think the portrait was painted?
  - o Who might the two girls be?
  - o What do their facial expressions and general pose suggest?
  - o What could the relationship between them be?
  - o Is there anything unusual about the painting?

- In feedback, tell students that this 18th-century portrait was the only one of its time to show a white girl and a black one in a sisterly pose and that to someone living back then, the image would have been shocking: an expensively dressed black girl on an almost equal social level with her white companion.
- Tell students they are going to listen to the beginning of a trailer made for the film Belle, depicting the black girl's life (Dido Elizabeth Belle Lindsay).
- Tell the students:
  - o Belle's father comes to take her away to England.
  - o What do you think he looks like?
  - o How old is he?
  - o How tall?
  - o What kind of clothes is he wearing?
  - o How old do you think Belle is?
  - o Is she happy or sad?
  - o Is the uncle of Belle's father going to accept her in his home?
- Play the first 35 seconds of the trailer while the students keep their eyes closed and focus on trying to imagine the answers to the questions: <http://www.belle-themovie.com/#/media>.
- After the students discuss their answers, play the trailer extract again, this time with image on, and say that Belle is reluctantly taken in by her father's uncle, Lord Mansfield, to be raised alongside her cousin, the white girl in the painting.
- Tell students that, years later, Belle meets John Davinier, someone who doesn't have a high position in society but would like to become a man of law. 'I wish to make the laws not only administer them, for that is how I may truly change this world', he says.
- Ask students to individually circle numbers on Worksheet 1, then group those with similar answers together so they can come up with arguments for their choices. There will probably be two sides – agreement versus disagreement – that can afterwards have a debate.
- Ask students if they know of a historical event known as The Zong case, on which Lord Mansfield, as head of law in England, had to make an important legal decision. Explain that it involved the mass murder of 134 enslaved Africans insured as cargo who were thrown overboard because there presumably wasn't enough water for the whole crew to survive the trip.

- Tell students they will now do research on this case as part of a project involving filming their very own Zong trial.
- Teach some trial-related vocabulary first: indict, allege, sue, prosecute, acquit, appeal, defendant, evidence, litigate, plea, witness, testimony, insurance fraud.
- Distribute Worksheet 2 as a model for the students' note-form research. Other fact sheets could be done for:
  - o Captain Collingwood (who died before the trial even started)
  - o Granville Sharp (a great fighter for abolitionism at the time)
  - o Robert Stubbs (a deeply flawed character on board the Zong at the time of the events, who nonetheless gave evidence in court)
  - o John Lee (the Solicitor General notorious for his infamous association of slaves with wood being thrown overboard)
  - o Mr Pigot (the insurers' representative who claimed that everyone on board a slave ship should be treated equally).
- Once the research is done, ask students to decide on a script for the film. Encourage use of creativity,

for instance a modern take on the case. Groups of up to five students can spend a whole lesson working on their scripts with you assisting informally with language work.

- Then roles have to be distributed, costumes and props thought of and designed, and lines rehearsed. The more tech-savvy students in the class can then be in charge of filming and editing.
- Each group then performs for the rest of the class.

### Follow-up

- The students' re-enactment of the Zong case could be performed for other classes on special occasions such as Anti-Slavery Day (18 October) or Human Rights Day (10 December).
- Remind students of some significant years: 1781 – Zong massacre; 1783 – an end to the slave trade is publicly demanded by a few individuals in Britain; 1787 – 60,000 people petition Parliament with the same aim; 1807 – the African slave trade is abolished.

### Additional resources

The Zong 1781–1783

- A brief summary from BBC Bitesize: <http://www.bbc.co.uk/education/guides/zqv7hyc/revision/9>

## Materials

### Worksheet 1

For each statement below, circle a number depending on how much you agree with it (1 – strongly disagree; 5 – strongly agree). Then compare answers with a partner and give reasons for your opinions.

1. Laws are meant to change the world.	1	2	3	4	5
2. It is institutions, not ordinary people, that can make a real difference in the world.	1	2	3	4	5
3. Better no institution than a corrupt institution.	1	2	3	4	5
4. 'If [a law] is of such a nature that it requires you to be the agent of injustice to another, then, I say, break the law.' (Henry David Thoreau)	1	2	3	4	5
5. 'At his best, man is the noblest of all animals; separated from law and justice he is the worst.' (Aristotle)	1	2	3	4	5

## Worksheet 2

Lord Mansfield
<p>Background</p> <ul style="list-style-type: none"><li>• born a poor Scottish nobleman</li><li>• great educational achievements</li><li>• preferred the Law to the Church</li></ul>
<p>Family life</p> <ul style="list-style-type: none"><li>• married Lady Elizabeth Finch</li><li>• didn't have children of his own but adopted two nieces (Elizabeth and Belle)</li></ul>
<p>Personality</p> <ul style="list-style-type: none"><li>• generous, hospitable, sociable, talkative</li><li>• blunt and impatient with inefficiency</li></ul>
<p>Accomplishments</p> <ul style="list-style-type: none"><li>• became Lord Chief Justice in England</li><li>• modernised English law and court system, e.g. sped up court procedures and cut through bureaucracy</li><li>• helped law students learn and improve</li><li>• thought to be 100 years ahead of his time</li><li>• made revolutionary decision in the Zong case which contributed to the abolition of slavery in Britain</li></ul>
<p>Reputation</p> <ul style="list-style-type: none"><li>• always fair</li><li>• determined to separate the personal from the professional</li></ul>
<p>Role in the Zong case</p> <ul style="list-style-type: none"><li>• had to make a decision in favour of either the insurers who refused to pay for the drowned human cargo or the ship owners claiming compensation for their loss</li></ul>
<p>Famous for saying</p> <ul style="list-style-type: none"><li>• 'Fiat justitia, ruat coelum' ('Let justice be done, though the heavens may fall')</li></ul>

## Activity 2: Martin Luther King, Jr.

### Aims

- For students to become familiar with one of the most important speeches in history, and find inspiration to work towards a fairer future

### Language focus

- Practice in using rhetorical devices; chunking, connected speech, sentence stress, intonation; third conditional

### SDG focus

- King's life-work has direct relevance to both SDG 16 and SDG 10: Reduced inequalities.

### Creative focus

- Transition from King's dream to the focus on students' own dreams for the future world

Level B1+  
Age 14+  
Time 60–120 mins

### Preparation

- You will need to be able to show Selma film extract: [https://youtu.be/\\_03qpPNPEI](https://youtu.be/_03qpPNPEI).
- Make copies of Worksheets 1–3. See Materials.
- You will need to be able to show 'I Have a Dream' full speech: <https://youtu.be/I47Y6VHc3Ms> or give students the transcript from: <http://www.foxnews.com/us/2013/08/27/transcript-martin-luther-king-jr-have-dream-speech.html>

### Procedure

- Ask students to discuss the question 'If you had the chance to publicly demand something of great importance, what would it be and why?'
- Get them to work in pairs then report back to the class.
- Tell students there was a revolutionary public figure who, when giving speeches, repeatedly asked for something that would ultimately change the world for the better: a law giving every citizen the right to vote. Ask for guesses as to who this person might be.
- Play the short Selma video several times until the students answer these questions:
  - o Who is the speaker?
  - o Why is voting so important, according to him?

- o How does he encourage his listeners to go about being granted this right?
- Ask students to tell you the name of Martin Luther King's most famous speech, then give them Worksheet 1 with the cut-up background cards to the 'I Have a Dream' speech.
- Explain that one of the things that made King's speech so remarkable was his use of three significant rhetorical devices: ethos (credibility or character of the speaker), pathos (emotional connection to the audience) and logos (logical argument).
- Ask students to match these to three excerpts from his speech on Worksheet 2.
- Either play the full speech or hand out the transcript for students to find other examples of ethos, pathos and logos.
- Go through possible answers, then tell students to think of a worthwhile bigger-than-self dream, e.g. university education available to all, and some arguments they could use in a speech advocating it. Worksheet 3 will help them organise their ideas, after which they can share them in groups.
- Students proceed to create their own 'I Have a Dream' speech, based on the issue they have chosen. You monitor and offer help as needed.
- Before students deliver their speeches, allow time for them to rehearse their speeches.
- Ask students to film their speeches, which can then be shown to other classes and as part of special Martin Luther King, Jr. events.

### Follow-up

- Students watch the film Selma (2015, Paramount Pictures), depicting the last years of King's life, and write a synopsis for it in class. Or they can produce a short summary of a possible prequel to the film focusing on earlier events of King's life. This will mean they will need to research King's life online.
- Discuss: 'If King hadn't died so soon, what other dream would he have had? Would it have come true?' Students think about this and come up with a 'What if ...?' story.

## Materials

### Worksheet 1

Put the cards in the right order of the events leading up to the 'I Have a Dream' speech.

Dr Martin Luther King, Jr. delivered his famous 'I Have a Dream' speech in 1963 to an audience of more than 200,000 people who came together from all over the United States for the March on Washington for Jobs and Freedom.
1963 was a time in American history when areas such as education, employment, housing, and voting were severely affected by racial discrimination and injustice. Black and white children had to go to separate schools, and many landlords refused to rent houses to black families, forcing them to live in poor and overcrowded neighbourhoods.
In the months leading up to the March, there was a lot of frustration at racial inequity in black communities. Demonstrations by African Americans and confrontation with police were common. By the end of 1963, 20,000 activists had been arrested and over 900 demonstrations had taken place in over 100 cities.
Dr King, a Baptist minister, won the Nobel Peace Prize when he was only 35 years old. A follower of the philosophy of Mahatma Gandhi, King is one of the world's best-known modern advocates of non-violent social change. Four years after the March on Washington, he was assassinated in Memphis, Tennessee. However, he lived to see part of his dream fulfilled when the Civil Rights Act, outlawing discrimination based on race, colour, religion, sex or national origin, was passed in 1964.

### Worksheet 2

Match rhetorical devices 1–3 to examples a–c from 'I Have a Dream'.

1. Ethos	a. 'I have a dream that my four little children will one day live in a nation where they will not be judged by the colour of their skin but the content of their character.'
2. Pathos	b. 'America has given the Negro people a bad check, a check which has come back marked "insufficient funds".'
3. Logos	c. 'Five score years ago, a great American [Abraham Lincoln], in whose symbolic shadow we stand today, signed the emancipation proclamation.'

Answers: 1 – c; 2 – a; 3 – b.

### Worksheet 3

What is my dream?	
Why is it important?	
What obstacles stand in its way?	
How can it be achieved?	
How long might it take for it to come true?	
Who is my audience?	
What authority can I quote in support of my dream? (ethos)	
What appeal to emotion can I make to persuade my audience? (pathos)	
What logical arguments can I provide? (logos)	

### Activity 3: Malala Yousafzai

#### Aims

- To raise awareness of how powerful a child's voice can be in the fight for fundamental human rights to be granted to all, and the need for young people to be proactive in addressing areas of injustice in the world.

#### Language focus

- Second conditional
- Letter/email-writing conventions
- Modal verbs of obligation
- Scanning skills in reading

#### SDG focus

- Several apply here – SDG 4 (ensuring inclusive quality education for all), SDG 5 (achieving gender equality) and SDG 16.

#### Creative focus

- Most of the projects below encourage students to come up with their own ways and means to support an ideal, with the teacher acting solely as prompter and facilitator of creative ideas.

Level B1+  
Age 14+  
Time 60 minutes

#### Preparation

- You will need to be able to access the video of Malala's United Nations speech: [https://www.youtube.com/watch?v=QRh\\_30C8I6Y](https://www.youtube.com/watch?v=QRh_30C8I6Y)
- Make copies of Worksheet 1. See Materials.

#### Procedure

- Revise the concept and form of the second conditional, then ask students to talk together about how they would complete this sentence:
  - 'If I lived in a world where I couldn't go to school ...'
- After discussing possible consequences and feelings as a class, tell students this is the world in which the youngest winner of the Nobel Peace Prize ever – Malala Yousafzai – was born, and that she was actually shot because of her advocacy of education for all. Use the links in Additional resources below to give further information about Malala.
- Play the video of Malala's United Nations speech in 2013 and ask students to make notes on Worksheet 1. Then discuss possible answers as a class.

- There are a few projects students can develop in the spirit of Malala's words, 'Let us pick up our books and our pens. They are our most powerful weapons. One child, one teacher, one book, and one pen can change the world.' For example, ask different groups in the class to identify situations that affect either them personally or the entire world.
- After researching them, students could 'pick up [their] most powerful weapons' and write a letter or email to the people who are in a position to change them for the better.
- Go over letter/email-writing conventions first, including useful functional language, and encourage use of appropriate (semi-)modal verbs of obligation (must, mustn't, should, ought to) in order for the piece of writing not to sound too pushy.
- Groups of students then exchange letters/emails and give each other feedback prior to sending them.

#### Follow-up

- Make a short film showing why children's rights – and the conditions in which they can actually be respected, like a peaceful society – really matter and how Malala is an inspiration in this respect.
- Create a free website (<https://www.weebly.com/> and <http://www.wix.com/> are two common options) dedicated to the students' causes, detailing action plans to address the problems.
- Research different initiatives aimed at ensuring equal access to education worldwide, such as 'Let Girls Learn': <https://www.usaid.gov/letgirlslearn>, in order to join at least one.
- Play the trailer of the 2015 Fox Searchlight Pictures documentary He Named Me Malala: <https://www.youtube.com/watch?v=vE5gSHJkusU> in class. Students either watch the entire documentary or do some online research in order to comment on the significance of Malala's name in relation to the legend of Malalai of Maiwand, the girl whose bravery reportedly inspired the Afghan army to defeat the British in 1880. The scene can be re-enacted in class or reinterpreted and then filmed by the students.

#### Additional resources

##### The Malala Story

- This site has a timeline of Malala's life and work: <https://www.malala.org/malalas-story>



## Materials

### Worksheet 1

1. Who does Malala speak for?	
2. Why does she mention Martin Luther King and other authority figures?	
3. What has made her adopt the philosophy of non-violence?	
4. How does she connect education to peace?	
5. What other countries does Malala speak about and why?	
6. What is the main message of her speech to the world and its leaders?	



# 18

## Sustainable Development Goal 17: Strengthen the means of implementation and revitalise the global partnership for sustainable development

Jennifer Verschoor and Anna Maria Menezes

### Introduction

The activities described in this chapter are related to Sustainable Development Goal (SDG) 17, which aims to strengthen the means of implementation and revitalise the global partnership for sustainable development.

The 17th SDG:

*recognizes multiple-stakeholder partnerships as important vehicles for mobilizing and sharing knowledge, expertise, technologies and financial resources to support the achievement of the sustainable development goals in all countries, particularly developing countries. (UN, 2016)*

This goal is of high importance because all the other SDGs are reliant upon it.

The world today is more interconnected than ever before. Consequently, improving access to technology and knowledge is an important way to share ideas and foster growth. We want to help children to be connected in order to become global citizens, understand cultural differences and help their local society by accessing knowledge.

Our objectives for the development of the activities below are to:

- strengthen global partnerships so as to understand cultural differences and reflect about local and world problems
- use technology as a way to discuss possible solutions to these problems
- encourage students to participate in local and global projects in order to empower them with the necessary knowledge and skills to become 21st-century learners.

### Activity 1: Global connection using the Hour of Code

#### Aims

- To enable students to take part in the 'Hour of Code' as an introduction to computer science
- To demonstrate that anybody can learn how to code

#### Language focus

- Following directions using: move forward, turn right, turn left

#### SDG focus

- SDG 17 – This activity links with technology and innovation, and enhances knowledge-sharing.

#### Creative focus

- Students will learn the foundations of computer science, concepts which are used for the creation of an online game. They will need to think creatively to complete the coding activity.

Level A2+

Age 9–10 years

Time 60+ minutes

#### Preparation

- Students need to have a computer or mobile device connected to the internet and the Angry Birds link available at: <https://studio.code.org/hoc/1>

#### Procedure

- Ask students about the following terms: coding, computer science. Write ideas on the board and the definitions.
- Show students the inspirational video from Code.org at the start of your class at <https://youtu.be/bQilo5ecSX4>, explaining what a program is.

- Ask students to turn on their laptops, personal computers or mobile devices and go to: <https://studio.code.org/hoc/1>
- Students need to create code and programme to help Angry Bird through a maze to get to the evil pig that stole his eggs.
- Students will be using a visual programming language called 'Blockly'. To write a code they will need to drag and drop blocks. Blocks are codes with the following instructions: move forward, turn left/ right. As students advance, they must use different blocks to complete the activities.
- Students need to understand how to use Blockly to write code.
- Blockly is split into three main parts.
  - o On the left is the bird maze, where the program runs and where you will find the instructions for each level.
  - o In the middle toolbox students build the code by giving a command that the Bird will understand, e.g. move forward, turn right or turn left.
  - o The right side is called the workspace. Here you build your program. Students will drag and drop the blocks to the workspace to build the program.
  - o The left side is where the program runs.
  - o The main objective is to get Angry Bird through a maze to hit a Green Pig.
- Ask students to start coding and go over the instructions on the left-hand side of the bird maze.
- If students are in pairs, instruct them to take turns using the keyboard.
- Encourage students to collaborate and problem-solve the codes together.
- Challenge students to complete the 20 blocks of code.
- Students need to complete 20 blocks of code to receive a certificate.

### Follow-up

- Take part in the Hour of Code event which takes place twice a year. Students from all around the world are encouraged to start exploring their first steps into the world of computer science and coding. For more information on how to attend this event, go to: <https://hourofcode.com>.

- Teachers can host an Hour of Code by organising an event at their own school. To join this movement they need to register here: <https://hourofcode.com> <https://hourofcode.com/ar/gb> - join.

## Activity 2: No more digital divide

### Aims

- To enable students to collaborate with students from different parts of the world in order to brainstorm ideas on how to diminish the digital divide found in many developing countries

### Language focus

- Using 'can', 'could' and 'might' to brainstorm possible solutions to a problem

### SDG focus

- SDG 17 – The activities are related to global awareness. Students should understand the economic, social and cultural situation in the world and issues affecting their countries.

### Creative focus

- To develop students' creativity and push them to find innovative solutions to problems, so that no one is left behind

Level	B1+
Age	15+
Time	60 minutes

### Preparation

- Create the virtual board at <https://padlet.com/> and set the configuration so that students can add their contributions.
  - o This is a tutorial which can help you set up the wall: <https://www.youtube.com/watch?v=UuzciL8qCYM> .
- Ask students to bring their earphones, laptops, tablets or mobile phones to the class.

### Procedure

- Write the words 'digital divide' on the board and ask students to try to guess what it is or if anyone knows its meaning.
- Divide the class into three groups. Ask each group to watch a specific video on their mobile phones and take notes of what they understand about the Digital Divide and Knowledge Divide.
  - o Group 1: <https://www.youtube.com/watch?v=qQD5soc2r7Y>

- o Group 2: <https://www.youtube.com/watch?v=cLFDDQi9ow4>
- o Group 3: <https://www.youtube.com/watch?v=LNIhzuTSRFU>
- After watching their video, each group compares their notes and checks that they all understood the topic. They choose a representative from the group to explain what they understood in the next step.
- Debriefing: Representatives from each group explain to the rest of the class what they understood or didn't understand about the topic.
- Groups choose one more video from the three listed above. They watch and compare it with their first video.
- Give these guiding questions to answer on a piece of paper:
  - o How are the videos different?
  - o How are they similar?
  - o What new information did you learn?
- Debriefing: In a big group, ask volunteers to read their answers.
- Discussion in groups of four: Write the following questions on the board so that groups can discuss:
  - o Have you noticed some form of digital divide where you live? If so, tell your group about it.
  - o How can we diminish the digital divide where we live?
  - o Can you as an individual do something to help this problem? If so, explain what it is.
- Finally, invite students to complete a virtual board created at <https://padlet.com/> with ideas on how to diminish the digital divide in developing countries.

### Follow-up

- Invite other groups of students by using the free version of Skype in the classroom to connect and share learning experiences with different countries. To participate in Skype in the classroom all you need to do is download Skype and set up a Skype ID. Go to <https://education.microsoft.com/skype-in-the-classroom/skype-lessons> and browse or create content to find the perfect learning activity for your students, then request a session.

### Additional resources

BBC – World wakes up to digital divide

- This article defines the digital divide as a global issue: <http://news.bbc.co.uk/2/hi/technology/8568681.stm>

### Activity 3: Caring for our water resources

#### Aims

- Identifying local water-related issues and possible solutions
- Promoting local and global awareness for water-related problems

#### Language focus

- Making questions and preparing a report

#### SDG focus

- SDG 17 – This activity is related to global awareness because students will analyse water-related issues in their country by gathering and refining information from their school. It will also build awareness of the power of reports to share knowledge and encourage partnerships.

#### Creative focus

- Students will engage creatively by preparing a water audit of their school building and preparing a report on ways and means to save water.

Level B2+

Age 13+ years

Time 120 minutes

#### Preparation

- Students need to inspect all the places where water is used through the school. Each team needs a pencil/pen, camera, set of worksheets and a marker pen.

#### Procedure

- Teacher introduces the topic of water in geography by sharing some beautiful landscapes of lakes, rivers, seas and oceans in their country or town. You can bring to class different pictures or project the information on the board.
- Ask students to sit in pairs to discuss different ways in which water is used: drinking, cooking, recreational purposes, farming.
- Debriefing: On the board, elicit the ideas suggested by the students.

- Make students identify how water is wasted at school and home by creating a list on a sheet of paper. Share the ideas orally with the rest of the classroom.
- Create an 'I conserve' poster with all their ideas or create a pledge to conserve water.
- Students must prepare a water audit of their school building. First, they must find out where water is being used in their school. In small teams, they must identify water-related issues such as the fixtures that are leaking and record the data on a set of worksheets. In the audit report students must include: number of toilets (boys, girls, staff), wet areas, number of sinks, drinking fountains, pool, showers, changing rooms, water features and leaking taps or toilets.
- One student of each group is responsible for record-keeping and should take photographs of the different school areas they analysed.
- Once all the data is collected they can share their findings with the rest of the classroom.
- Students must prepare an individual report on ways and means to save water based on all the information gathered. Each report should introduce the main idea, explain and expand that idea, present relevant evidence to support solutions and share their conclusion.

### Follow-up

- Create a bulletin board on caring about our water resources. Add the poster or pledge you created in the above-mentioned activity. Make the rest of the students aware of the local water issues your school is facing by making students read some of the reports created after auditing the school.
- Students can create their school report using Tackk: <https://tackk.com/>. Here there is a tutorial showing how to create a Tackk page: <https://www.youtube.com/watch?v=poildGfG8zY>.

## Activity 4: Time to recycle

### Aims

- To educate students about the importance of recycling and to reflect about the recycling problems they face in their country or local area

### Language focus

- The use of simple present and descriptive language to talk about problems

### SDG focus

- SDG 17 – Students look at ways to recycle rubbish and then explore ways to share their knowledge and involve others.

### Creative focus

- After learning the basics of recycling, students can be creative with a can or yoghurt pot by making a musical instrument such as a drum or shaker.

Level B2+  
Age 9+  
Time 1 hour

### Preparation

- You need to make sure students have a tin can or large yoghurt pot, pieces of paper, rice, beans, glue, paint and an elastic band.

### Procedure

- Ask students to sit in groups of four and brainstorm about how to reduce waste, share what they know about recycling and discuss what they know about reusing things.
- Debriefing: On the board, elicit the ideas suggested by the students.
- Place two bins in front of the class one labelled 'Recycling' and the other labelled 'Rubbish'.
- Bring to class different items you found in the school bin and make students line up, pick an item and place it in the correct bin.
- Be sure to have a large yoghurt pot, a piece of paper and an elastic band.
- Demonstrate to students how to reuse things. Follow these three simple steps:
  - o Use a clean can and remove the ring pull. You can fill the can with beans or rice.
  - o Seal the can with a piece of paper on the top and decorate it or paint it any way you want.
  - o Be sure to seal every part of the can before you start shaking the can and enjoy it.

- Now ask the students to think of ways they can share this idea and get other students interested in recycling and creating instruments or toys from rubbish.
- Help students create videos based on how to reuse things instead of throwing them away.
- Students could watch each other's videos and reflect about their creations.
- Ask students to work in pairs and create a video story using the app: <https://spark.adobe.com/about/video>.
- After creating their video, they share their production with the whole group on a social network website used by the class or have pairs present their creation to the whole class.
- Students can explore the app by watching this tutorial at: <https://www.youtube.com/watch?v=N7PjfUGcE6A>.

### Follow-up

- Students can think of different recycling activities, for example creating a drum with a large yoghurt pot, a piece of paper and an elastic band.
  - o Students need to find a large yoghurt pot and clean it.
  - o Cover over the top with any kind of strong paper and put the elastic band over the top.
  - o Tap on the top of the recently created drum and have fun with your instrument.

### Activity 5: We have a solution

#### Aims

- To help students reflect on how people have been trying to solve problems around the world and to encourage them to think of alternative solutions for local problems

#### Language focus

- Making suggestions, and narrative language to describe past initiatives to solve problems

#### SDG focus

- SDG 17 – This activity is related to local empowerment. By familiarising themselves with creative initiatives from around the world, students will be invited to reflect about solutions for local problems.

### Creative focus

- Creating a video to describe an interesting initiative for solving a problem

Level B2+  
Age 13+  
Time 1 hour

### Preparation

- Create a virtual room at <http://todaysmeet.com>.
- Ask students to bring their digital devices to class.

### Procedure

- Write the following on the board:
  - o 'Poor people in Brazil need lights in their houses, but they can't afford to pay expensive electricity bills. What do you think could be done to help these people?'
- Invite students to use their mobile phones or tablets to write their suggestions in the virtual room you have already created at <http://todaysmeet.com>. Students can read each other's texts and develop a conversation, pointing out problems they foresee about the suggestions given. Allow students to share their ideas for about 15 minutes.
- Show a video about the solution found by a Brazilian for the problem: <https://www.youtube.com/watch?v=p8BGxYYK4ac>.
- After showing the video, ask students to describe the solution and their impressions.
- Ask them if they know of any other interesting ideas people have already had to solve important problems like this.
- They work in groups of three and search for an interesting idea to solve relevant problems such as poverty, crime, lack of education, infant mortality, deforestation and endangered species on YouTube or Google. This search can be done in class or assigned for homework.

### Follow-up

- After searching for a good idea, the groups can create a video using the website/app: <https://animoto.com/>, first explaining the problem and then describing the solution found.

## **Additional resources**

BBC Changing the Rules

- This is an interesting section of the site where students can read about how people have been trying to change their realities: <http://www.bbc.com/news/business-36025383>

Edutopia – Social Entrepreneurship: 7 Ways to Empower Student Changemakers

- This is an interesting article to inspire teachers to help empower their students: <https://www.edutopia.org/blog/empowering-student-changemakers-vicki-davis>

Global Digital Citizen – How to empower students to create change

- An interesting post which shows that social change can be implemented by people at any age: <https://globaldigitalcitizen.org/empower-students-create-change>

## **References**

UN (2016) Open Working Group of the General Assembly on Sustainable Development Goals. Available at <http://undocs.org/A/68/970>. Accessed on 18/8/2016.



# 19

## Content and the Sustainable Development Goals: Going beyond language learning

Adrian Tennant

### Introduction

As educators, our job goes beyond teaching our subject, whether that be language, science, humanities or any of the other subjects taught in schools, colleges and other educational establishments. Our responsibilities should include empowering learners and creating people capable of critical thinking, problem-solving and becoming global citizens in an ever-changing world.

Co-operation and collaboration are the keys here as they foster skills that are key to students' development in the 21st century and they enhance students' language learning skills. In this chapter I have included activities designed to raise students' awareness and get them thinking of solutions to some practical problems, as well as engaging them in tasks that require creativity and collaboration.

The activities in this chapter link to one of the following three SDGs:

- Goal 7: Ensure access to affordable, reliable, sustainable and modern energy for all
- Goal 13: Take urgent action to combat climate change and its impacts
- Goal 12: Ensure sustainable consumption and production patterns

In many respects the first two of these are complementary and some people would argue that consumption and waste are also linked to them. Helping our students to understand the issues is important, but giving them hope by showing them that there are solutions is probably even more important.

The idea of combining English with content is nothing new. The idea of having content when we learn language is key to learning to use language rather than simply learning 'about' the language. This book gives us all the opportunity to link learning language with content that is interesting, useful and memorable.

### Activities

According to the UN (<http://www.un.org/sustainabledevelopment/energy/>) 20 per cent of the population of the world still lacks 'modern' electricity; 3 billion people still have to use wood, charcoal and animal waste for cooking and heating (often leading to health problems) and around 60 per cent of all greenhouse gases are from energy that we use. Finding clean, affordable and sustainable energy has to be a priority.

### Activity 1

#### Aim

- To raise awareness of issues connected to energy use

#### Language focus

- I/We use ...; What kind of ...?

#### SDG focus

- SDG 7: Energy

#### Creative focus

- Thinking critically about energy use

Level A2+

Age 8+ / teens

Time 20+ minutes

#### Preparation

- Make a worksheet or display with the questions.

#### Procedure

- Put the students in groups and ask them to discuss the questions below.
- Monitor as they work and try to feed in any vocabulary the students need.

**Try to answer these questions together.**

1. What is energy?
2. What things do you have in your house that require/need energy? Make a list.
3. What kind of energy do each of these things use/need, e.g. gas, electricity, etc.
4. Where do you get this energy from?
5. How is it made or accessed?
6. What would happen if you only had 5 per cent of the energy you use at the moment?
7. Which of the things you have in your house do you think you couldn't live without? Why/Why not?
8. If you didn't have the energy you needed for everything, what could you do instead?

- Get students to change groups to share and compare their answers.
- Brainstorm the answers as a class and try to draw a mind-map as a way of recording ideas on the board in your classroom.

## Activity 2

Many young people, certainly in developed countries and in many urban areas, take things like electric lighting for granted. Not only do they not know where their electricity supply comes from and how it is generated but they don't really think about what it would be like not to have lighting at the flick of a switch. When there are power cuts it's amazing to see how quickly people start to miss things they take for granted. On the other hand, for children who do experience intermittent electricity or issues to do with reliable energy, it is helpful to start thinking 'outside the box' and know that creative solutions do exist.

### Aim

- To look at a solution for affordable and 'green' lighting

### Language focus

- Following instructions and sequencers, e.g. first, then, finally. Possibly language of speculation, deduction and reasoning.

### SDG focus

- SDG 7: Energy

### Creative focus

- Problem-solving

Level B1+  
Age 8+ / teens  
Time 30+ minutes

## Preparation

- You will need access to this video on YouTube: <https://youtu.be/qaSdb361nKs>.
- You will also need a big cardboard box, scissors, 1–1.5 litre empty plastic bottles, water, bleach (optional), cardboard.

## Procedure

- On the board write up the following question:
  - o 'How can you have a light in your house if there is no electricity?'
- Put the students in groups and give them two minutes to discuss the question.
- Elicit their ideas and write a few up on the board.
- Tell the students they are going to watch a video. While they watch, you want them to listen out for answers to two questions:
  1. When did Alfredo Moser come up with the idea for the invention?
  2. What are the two main problems with the invention?
- Play the video from: <https://www.youtube.com/watch?v=qaSdb361nKs>.
- Put the students in pairs and get them to check their answers together.
- Give the students the following set of instructions and ask them to watch the video again (particularly the section from 00:16 to 00:40) and put the instructions in the correct order.

### Number these instructions in the correct order

	Around the edges of the hole put some polyester resin to make a rain-tight seal.
	Cut a hole in the roof.
	Make a hole in the aluminium foil.
	Pour some water and a little bit of bleach into a plastic bottle.
	Put the bottle through the hole and fix with glue.
	Put the bottle through the hole. The foil should stop it falling all the way through.

- Put the students in pairs and get them to check their answers together.
- Put the students in small groups and give each group a set of the materials – but not the large cardboard box.
- Show the students the following instructions:

#### Instructions

1. Place the bottom of the bottle on the cardboard and draw a circle around it.  
Draw another circle inside about 0.5 cm inside the first circle.
2. Cut out the inner circle.
3. Every 1.5–2 cm cut lines from the inner circle to the edge of the outer circle.
4. Fold the cut sections upwards to create a ‘fan’.
5. Put the cardboard hole over the top of the bottle and push down a little bit.
6. Fill the bottle with water (and put a small amount of bleach into the water).
7. Screw the top back on the bottle.
8. Place the bottle through a hole cut in the top of the big cardboard box (your teacher will prepare this).

#### Note

You should cut a hole in the top where the students can place their bottles and a small window (with a flap) in the side of the box where students can look inside the box and see their ‘solar bulb’ working.

#### Follow-up

- Discuss why they think the lamps work and how they could be improved.
- If you’d like a ‘strong’ language focus here you can put some phrases up on the board e.g.
  - o I think it works because ...
  - o It must be because of ...
  - o What happens if we ...

### Activity 3: Climate change

Most of our students will have heard of climate change, but do they understand what the words mean? The next activity tries to look at some of the key facts in a fun and engaging way.

#### Aim

- To engage students with issues about climate change

#### Language focus

- I think ...; I'm not sure ...

#### SDG focus

- SDG 13: Climate change

#### Creative focus

- Discussing options

Level A2+

Age 8+ / teens

Time 15–20+ minutes

#### Preparation

- Make copies of the quiz (one per pair or small group).

#### Procedure

- On the board write up the words: 'climate change' and elicit what the students already know about the topic.
- Write up some of the ideas/information they give you on the board, but don't comment on it yet.
- Tell the students you are going to give them a quiz with eight questions about climate change.
- Put the students in pairs or small groups and ask them to discuss how many questions they think they will get correct (don't show them the quiz yet).
- On the board write up some prompts for the students to use when they are speaking together.
  - o I think ... is the correct answer.
  - o I agree/don't agree because ...
  - o Are you sure? Why do you think ... is the correct answer?
- Hand out the quiz and give the students about five or six minutes to discuss and answer the questions.

#### Climate change quiz

1. Gases that cause global warming are called ...
  - a) fossil gases.
  - b) greenhouse gases.
  - c) warming gases.
2. One cause of global warming is the increase in ... in the atmosphere.
  - a) carbon dioxide
  - b) hydrogen
  - c) oxygen
3. In the last fifty years average global temperatures have ...
  - a) decreased.
  - b) increased.
  - c) stayed the same.
4. The first animals to become extinct because of climate change were ...
  - a) dinosaurs.
  - b) dolphins.
  - c) golden toads.
5. The country which causes the most pollution is ...
  - a) China.
  - b) the UK.
  - c) the USA.
6. One consequence of global warming is that the seas and oceans are ...
  - a) disappearing.
  - b) rising.
  - c) getting deeper.
7. The amount of ice in the Arctic is ... every year.
  - a) decreasing
  - b) increasing
  - c) not changing
8. One consequence of climate change is more floods, droughts and extreme weather such as hurricanes. Is this ...
  - a) true?
  - b) false?

- Check answers together and see how many the students got right.

Key: 1.b 2.a 3.b 4.c (although some people might argue a) 5.c 6.b (although again a is possible if we think about places such as the Aral Sea in Central Asia) 7.a 8.true

## Note

Sometimes it's good if there is not one correct answer as this shows students just how complicated some topics are.

## Follow-up

- Get your students to do a project on climate change. There are some suggested websites listed in the Further resources at the end of this chapter.

## Activity 4: Rubbish

While students often think that there is little that they can do about climate change on a personal level, with the next topic – rubbish – it is much easier to see how we can make a personal difference. SDG 12 focuses on sustainable production and consumption. It looks at issues connected to energy, water and food and includes 12 targets. One of those targets is to reduce waste- generation through prevention, reduction, recycling and reuse. One of the entry points into this is actually to think about just what we mean by waste, or rubbish..

## Aim

- To think about what is or isn't rubbish

## Language focus

- It's a ...; It's made of ...; We can use it to/for ...

## SDG focus

- SDG 12: Sustainable consumption

## Creative focus

- Critical thinking – (alternative) uses of different items

Level A2+

Age 8+ / teens

Time 30+ minutes

## Preparation

You need to collect around eight to ten items prior to the lesson:

- a small stone, an elastic band, an empty plastic bottle, one sock, an old coin, a light bulb (not working), a cardboard tube (the inside of a toilet roll), a used tea bag.

## Procedure

- Start by showing each item one at a time and eliciting what it is, e.g. 'It's a small stone.'

- Next, show the items and ask the question 'What's it made of?' and elicit answers, e.g. 'It's made of plastic.' At this stage you might need to provide vocabulary such as materials.
- Then, on the board draw a chart with two columns, one labelled 'Useful' and the other one labelled 'Rubbish'.
- Put the students in pairs and ask them to decide together which column each item goes in. Encourage them to think of reasons for their selections.
- Discuss ideas as a class.

## Follow-up

- Have a discussion using the following questions:

### Discuss these questions.

1. How much rubbish do you throw away each week?
2. Do you try to recycle things?
3. What kind of things do you recycle?
4. Do you have special containers or bins for recycling?
5. If yes, are they different colours, e.g. green for paper, blue for glass?
6. How can we reduce the amount of rubbish we produce?
7. What happens to the rubbish we throw away?
8. How can we persuade people to produce less rubbish and to recycle waste?

## Activity 5: Getting it together

In this activity I'll link in one activity all three SDGs that have been the focus of this chapter: Energy (7), Sustainable consumption (12) and Climate change (13).

### Aim

- To look at energy used for cooking and some of the consequences

### Language focus

- Vocabulary connected to the topic of energy for cooking and sustainable resources

### SDG focus

- SDG 7: Energy, SDG 12: Sustainable consumption and SDG 13: Climate change

## Creative focus

- Problem-solving and critical thinking

Level B1

Age 8+ / teens

Time 15+ minutes

### Preparation

- Make a copy of the text for each student or pair.
- You will need access to this video on YouTube: <https://youtu.be/9VyWUVhcFyI>.

### Procedure

- Put students in pairs and give each pair a copy of the worksheet below.
- Ask them to complete the text using the words at the top.
- Encourage the students to work together.
- Monitor and help where necessary.

### Complete the text using these words.

animal breathing carbon dioxide cooker energy floods  
food global warming habitat natural smoke solar

One thing everyone needs (0) energy for is cooking, unless all you want to eat is raw (1) \_\_\_\_\_. According to the United Nations almost 40% of the population of our planet still use materials like wood or (2) \_\_\_\_\_ waste for cooking.

Using wood creates lots of problems. First of all, burning it releases (3) \_\_\_\_\_ into the atmosphere and this leads to (4) \_\_\_\_\_. Secondly, the smoke from wood fires can lead to (5) \_\_\_\_\_ problems. Often the stoves are in small rooms with nowhere for the (6) \_\_\_\_\_ to go. Finally, by cutting down the trees we change the (7) \_\_\_\_\_ environment. We reduce the (8) \_\_\_\_\_ of many animals and often the roots of the trees which hold the soil together and soak up water when it rains. In many places where people have cut down all the trees there are (9) \_\_\_\_\_ and droughts.

Some people are trying to find solutions. One idea is to use the power of the sun – (10) \_\_\_\_\_ power – to make heat rather than light. The idea is to have a solar (11) \_\_\_\_\_ made from very simple materials like cardboard and aluminium foil. These solar cookers are cheap, easy to make, safe and clean.

- Check the answers as a class and discuss the text together.

**Answer key:** 1. food 2. animal 3. carbon dioxide  
4. global warming 5. breathing 6. smoke 7. natural  
8. habitat 9. floods 10. solar 11. cooker

## Follow-up

- Show the following video which shows the problem first-hand in Bangladesh as well as a solution being tried: <https://youtu.be/9VyWUVhcFyI>.
- If your students enjoyed making a solar light in Activity 2, maybe they would like to have a go at making a simple solar cooker. Here is a fairly simple one that I've tried out a couple of times: <http://www.hometrainingtools.com/a/build-a-solar-oven-project>.

## Conclusion

The first thing that might strike some people is the relatively low level and young age indicated on the activities. With regard to the level, if you give students the opportunity to discuss things of interest, you will be surprised what they can cope with. In terms of vocabulary, a lot of the language is now part of the international arena, so if they are interested in the topics already, it may well be familiar. As for age ... the younger we get our students involved and aware in these issues the better. We are talking about the future of their planet, so surely they need to be aware and have the right to make choices.

Using the SDGs as a focus of our activities allows us to link important issues with topics that students will already be learning in school. A cross-curricular approach to learning helps give a purpose to the language being learned, over and above the structures, functions and vocabulary.

Finally, I would like to draw your attention to the importance of the 21st-century skills. Becoming global citizens, taking responsibility and, essentially, collaborating with each other, creativity, critical thinking and collaboration are at the heart of all the activities in this chapter. I hope that you will also be able to think beyond the activities presented here and go on to make your classes increasingly relevant to the needs of your students and their futures.

## Further resources

### Earth Hour UK

- You can find an interesting reading activity telling students more about Earth Hour: <http://learnenglishteens.britishcouncil.org/uk-now/read-uk/earth-hour-uk>

### Litter of Lights

- This site has more information about the solar bottle light students studied in Activity 2: <http://literoflight.org>

### BBC News

- An online news article about Alfredo Moser, the inventor of the solar lamp: <http://www.bbc.co.uk/news/magazine-23536914>

### Grameen Shakti, solar PV, stoves and biogas in Bangladesh

- A video about Grameen Shakti in Bangladesh: <https://www.youtube.com/watch?v=YewyIARlAlM>

### Climate Kids

- A simple site from NASA aimed at helping young students understand climate change: <http://climatekids.nasa.gov/climate-change-meaning/>





# 20

## Using extensive reading creatively to raise awareness of issues of equality and justice

Sue Leather

### Introduction

Anthropologists tell us that storytelling is central to human existence, that it is a common feature of every known culture. From infancy, every human being learns that stories carry narrative meaning. Stories can engage readers emotionally, having an effect on both attitude and motivation (Day and Bamford, 1998: 21–31). It is this emotional engagement which makes stories such an effective vehicle for the discussion of global issues. Stories are powerful; they engage us with the lives of individuals faced with problems. When we read them, they provoke the very human feelings of understanding and empathy. We experience the problems as the characters do.

My aim in this chapter, then, is to explore the ways in which teachers can make creative use of graded readers for discussion about current issues of equality, sustainability of land use and justice. The activities on offer here encompass gender equality, racial equality and equality of opportunity, even issues of peace and war. They are specifically intended to address the United Nations' Sustainable Development Goals 5: Gender equality, 10: Reduced inequalities, 15: Life on land and 16: Peace, justice and strong institutions. The chapter will give practical activities for published graded readers which each have both a language focus and a creativity focus. The activities will give you ideas about how to creatively engage your students, particularly before reading and after reading.

Research has given evidence of the many benefits which come from extensive reading (Day and Bamford 1998; Waring 2000, 2006). In its turn, the ELT world has recognised that graded readers are excellent sources of good stories which learners can read and enjoy in school or at home. Without necessarily paying intentional attention to the language itself, learners are able to gain access to massive amounts of comprehensible input (Krashen, 1993). It has been said that extensive reading in this way has a 'magical' effect on students' reading, grammar, vocabulary and other aspects of their language (Prowse, 1996). In other words, they can read for pleasure and learn to use language at the same time, by seeing it in context.

In addition to the 'reading for pleasure' function of graded readers, they are used by teachers in many contexts as sources of language work, vocabulary and discussion. In such contexts, teachers may use graded readers as set texts, setting reading for homework or in class, and doing whole-class activities based on the reading.

Graded readers can be love stories, thrillers, science fiction, detective stories, science fiction – a whole range of genres which appeal to many different types of readers. They are designed to be an easy, quick read for students who are coming to grips with the language. In addition, a significant number of them are stories which throw light on social issues with global relevance and they can be an excellent source of classroom discussion.

### Activity 1: Battle for Big Tree Country

#### Aim

- To predict/create stories based on pictures, blurbs, etc.
- To introduce and discuss the themes of the book

#### Language focus

- Skimming and scanning reading skills
- Predictive reading skills
- Oral storytelling

#### SDG focus

- SDG 10: Inequality, SDG 15: Ecosystems, Life on land – The story brings up the issue of the rights of Native Americans in North America, and also of land use.

#### Creative focus

- Using clues to imagine/create a story

Level B1+  
Age 13+  
Time 45–60 mins + reading time

## Preparation

- You will need to make copies of:
  - o the book cover – see Materials
  - o the book blurb – also in Materials.
- Students will also need to be able to access Nuu-chah-nulth on Wikipedia:  
<https://en.wikipedia.org/wiki/Nuu-chah-nulth>.

## Procedure

- Divide students into groups of three or four and ask them to appoint a team leader.
- Give each group only the:
  - a) front cover of the book with title
  - b) back cover blurb on board or handout
  - c) Wikipedia page on the Nuu-chah-nulth people.
- Give groups two questions on the board:
  - o What happens in the story?
  - o What are the themes of the story?
- Give the groups time to discuss the questions.
- Once they have finished, each group feeds back orally to the whole class.
- Accept all their ideas at this stage.
- Now you can get the students to listen to the audio from the book at home: <http://tinyurl.com/n6bbqzg>
- Once the class has listened to the book, come back to the two questions and ask students to compare their stories with the actual story.

## Follow-up

- If you have time and the materials, each group could design their 'story' on a large piece of poster paper. Each group then presents to the class from their poster.

## Materials

### Book blurb

When some of the tallest, oldest trees in the world are threatened by logging, 19-year-old Gail Klutesi, a Native Canadian from the Nuu-chah-nulth band, knows that she can't just stand by and watch. When Gail's protest group is broken up by the police, she makes a sudden decision that might change everything.

From *Strong Battle for Big Tree Country*. Page Turners 11, 1E. © 2015 Heinle/ELT, a part of Cengage Learning, Inc. Reproduced by permission.  
[www.cengage.com/permissions](http://www.cengage.com/permissions)

### Book cover

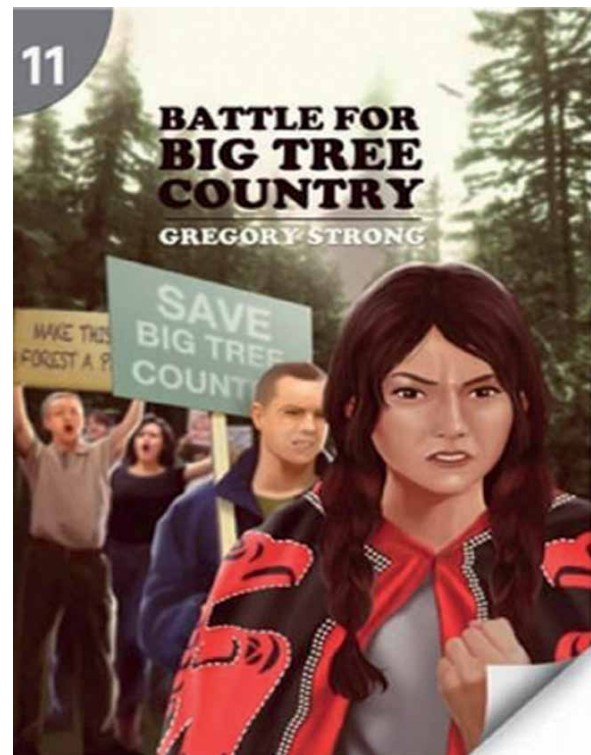

## Activity 2: The Choice

### Aims

- To construct effective reasons in an argument
- To discuss the themes of the book

### Language focus

- Listening and reading skills – listening and reading to a story
- Speaking skills – preparing and delivering an argument

### SDG focus

- SDG 5: Gender equality – The story is about a young woman who is faced with the choice between her career and having children. It involves the issue of how the issue may be perceived and experienced differently by men and by women.

### Creative focus

- Putting yourself in other peoples' shoes; creating a possible scene between two characters

Level A2+

Age 13+

Time 60+ minutes

### Preparation

- None

### Procedure

- Draw a picture or find a picture in a book of a man and a woman (they should both be around 30 years old).
- Tell the students:
  - o their names are Anna and Joe Mason
  - o they are married
  - o Joe has a good job
  - o Anna is a student at Cambridge University
  - o Anna is studying computer science and has been promised a very good job after she leaves university.

- Ask the students if they think they are happy.
- Now tell them that Joe wants to have children, but Anna wants to wait.
- Split the group into two and ask one half of the class to imagine they are Joe and the other half to imagine they are Anna.
- Now tell the group that are Anna to think of all the reasons why they shouldn't have children and why they should wait.
- Tell the group that are Joe to think of reasons why they shouldn't wait and why they should start a family immediately.
- Once the students have had time to think of reasons, put them into pairs with one Joe and one Anna. Tell them to role play a discussion between the two and try to decide whether they should have children or wait.
- Once they have completed their role plays get the pairs to tell you their decisions and explain why they made that decision.
- Now tell the students there is a story about Joe and Anna. Give them the link to the audio files and ask them to listen at home and find out what decision the couple come to: [http://www.cengage.com/cgi-wadsworth/course\\_products\\_wp.pl?fid=M20b&product\\_isbn\\_issn=9781424046553](http://www.cengage.com/cgi-wadsworth/course_products_wp.pl?fid=M20b&product_isbn_issn=9781424046553).

### Follow-up

- Get the students to discuss the problems women have when they want a career and children. Get them to think of ways it could be made easier for women to have both a career and a family.

### Additional resources

The Choice: Page Turners 6, 1st edition by Sue Leather

- This is the book that the story comes from: [http://www.cengage.com/cgi-wadsworth/course\\_products\\_wp.pl?fid=M20b&product\\_isbn\\_issn=9781424046553](http://www.cengage.com/cgi-wadsworth/course_products_wp.pl?fid=M20b&product_isbn_issn=9781424046553)

### Activity 3: Blood Diamonds

#### Aims

- To prepare students for the theme of the book
- To practise storytelling from pictures

#### Language focus

- Reading skills
- Note-taking
- Speaking – telling a story from pictures

#### Language focus

- SDG 16: Peace, justice and strong institutions – The story is about the trade in blood diamonds.

#### Creative focus

- Using pictures to tell their own story

Level B1+  
Age 13+  
Time 45–60 minutes

#### Preparation

- Find images of a man and a woman in their early 30s, an older businessman and a military man who could be a general.

#### Procedure

- Ask your students how they would feel if someone gave them a diamond. Get their reactions and get them to tell you what they would do with the diamond.
- Now ask them how they would feel if they knew that many people had died so that they could have the diamond. Ask them if they would still want to keep it.
- Tell them that some diamonds are called ‘Blood Diamonds’ or ‘Conflict Diamonds’. Ask them if they know what this is.
- Show them the image: [https://pbs.twimg.com/profile\\_images/595742192104275969/Ylfv-Anw.jpg](https://pbs.twimg.com/profile_images/595742192104275969/Ylfv-Anw.jpg).
- Tell the students that these diamonds are ones that have been sold to finance the purchase of arms and that many of the people mining the diamonds are treated as slaves.
- If your students have internet access give them a link to this infographic and ask them to find out about blood diamonds: [http://image.brilliantearth.com/blogprod/news/wp-content/uploads/2013/04/BE-Infographic\\_Final5.jpg](http://image.brilliantearth.com/blogprod/news/wp-content/uploads/2013/04/BE-Infographic_Final5.jpg). Or they could do some research online.

- Get the students to report back what they discovered.
- Now show the students the four images you prepared. Tell them that the man and the woman are journalists. Now show them the businessman and the general. Tell them the journalists have discovered that the businessman and general are importing blood diamonds into their country.
- Put the students into small groups and tell them to try to imagine a short story about the four characters and what happens. Ask them to make notes about the story (just bullet points to help them remember – not the complete text of a story).
- Once they have completed the story, ask the students to change groups and with a new partner tell them about the story they created.
- Lastly, get the students to discuss possible ways that the spread and trade in blood diamonds could be stopped.

#### Follow-up

- You could ask your students to buy and read Blood Diamonds by Richard MacAndrew: <http://www.cambridge.org/ca/cambridgeenglish/catalog/secondary/cambridge-english-readers/blood-diamonds-level-1>.

### Activity 4: Light

#### Aims

- To prepare students for the themes in the book
- To discuss the themes of the book

#### Language focus

- Vocabulary on the topic of freedom of speech
- Speaking skills – discussion about freedom of speech

#### SDG focus

- SDG 16: Peace, justice and strong institutions – The story is about an imaginary country where a dictatorial regime takes over and an artist is forced to defend her right to create the art she wants to create.

#### Creative focus

- Imagining what losing freedom of speech could mean; imagining how they would react in a dictatorship

Level B1+  
Age 13+  
Time 45–60 minutes

### Preparation

- None

### Procedure

- Write 'freedom of speech' on the board. Elicit briefly what freedom of speech means.
- Ask about students' own countries and freedom of speech – if that is possible. If they come from countries where it is not an issue, ask them what freedom of speech includes.
- Put students into small groups and ask them to appoint a note-taker. Ask them to imagine that they are in a country where there is no freedom of speech.
  - o What would happen?
  - o What kind of things would they not be able to do?
- They should make a list (e.g. not saying or writing what you want, not able to publish different ideas, no freedom to create art which criticises authorities, etc.). Go round and help with vocabulary as necessary.
- Take feedback from the note-takers in the groups. Ask what they would personally find most difficult.
- Ask students to think about whether they would do anything to react to such a situation. What would make them act? They discuss this in their groups.
- Take feedback from the groups.
- Explain the imaginary situation of Arda, an artist in a country called Galastia:
  - o Tell the students Arda is an artist and she makes sculptures.
  - o A military group called the Banda have taken over her country.
  - o The Banda have decided that her latest work 'Light' which is in the National Gallery should be destroyed.
  - o This makes her act.
- Put the students in groups and ask them to try to imagine the story and what Arda can do to stop her work from being destroyed.
- Once they have created their story, you can get the students to change groups and the pairs can tell each other their stories.

- You could follow this up with a discussion of art and censorship. Should works of art ever be censored? What would be an appropriate reason for censoring a work of art? Whose responsibility should it be to decide which art should be censored?

### Follow-up

- You can get students to read the story on which this scenario is based: Light by Sue Leather, Cengage Learning (2011).
- You can also have a discussion about freedom of speech and action after reading the book. If you do this, ask the students what provoked Arda to act, and what would bring them personally to action.

## Activity 5: Control Order 351

### Aims

- To prepare students for the themes in the book
- To discuss the themes of the book

### Language focus

- Writing – rules and orders using 'must'
- Speaking skills – presentation skills

### SDG focus

- SDG 16: Peace, justice and strong institutions – The story is about a dystopian, totalitarian future and how characters react to totalitarianism.

### Creative focus

- Imagining a dystopian future; creating a poster

Level B2+  
Age 13+  
Time 45–60 minutes

### Preparation

- Copies of prologue of book – Order 351. See Materials Worksheet 1.
- Large poster papers and marker pens

### Procedure

- Ask students to read the first part of the prologue from Worksheet 1.
- Ensure they understand the word 'totalitarian'.
- Elicit briefly some kinds of possible restrictions of freedom, starting 'Citizens must not ...'.

- Put students into groups of three or four. Each group has a large piece of poster paper and marker pens. If you don't have poster paper, students can do this activity in their notebooks and present orally.
- Ask the groups to imagine that they are the government of Britain in the scenario above. Ask them to make a list of orders for the citizens of the country. They should write as many as possible in 15–20 minutes.
- When each group has finished, ask them to stick their posters on the walls.
- Everyone walks around and looks at the posters. They should decide which is the most frightening/severe.
- Lead a plenary discussion about what it would be like to live in such a totalitarian place.

### Follow-up

- If you have time, you can ask each group to give a short presentation on their list.
- Ask students to read the book *Control Order 351*. Students can check whether their orders feature in it.

### Materials

#### Worksheet 1

#### The year is 2110.

The world is still recovering from a long global war over natural resources. With food, water, oil, minerals and other necessities now in short supply, countries are saving their scarce resources for themselves. Every country is on its own.

In this climate of suspicion and fear, a totalitarian government has come to power in Britain. For twenty years now, this government has restricted the freedom of British citizens in the name of national security.

From *Moses Control Order 351*: Page Turners 11, 1E.  
© 2014 Heinle/ELT, a part of Cengage Learning, Inc.  
Reproduced by permission. [www.cengage.com/permissions](http://www.cengage.com/permissions)

### Additional resources

British Council TeachingEnglish – Using Graded Readers

- A good overview of what teachers can do with graded readers: <https://www.teachingenglish.org.uk/article/using-graded-readers>

British Council TeachingEnglish – Why Extensive Reading is Good for our Students

- A useful article to remind us of the benefits of extensive reading by Alan Maley: <https://www.teachingenglish.org.uk/article/extensive-reading-why-it-good-our-students%E2%80%A6-us>

### References

Day, RR and Bamford, J (1998) *Extensive Reading in the Second Language Classroom*. Cambridge University Press.

Krashen, S (1993) *The Power of Reading*. Eaglewood, CO: Libraries Unlimited.

Prowse, P (1996) *The magic of readers*. BBC English, October 1996.

Prowse, P (2002) Top ten principles for teaching extensive reading: A response. *Reading in a Foreign Language* 14 (2).

# 21

## Storytelling for a better world

David Heathfield

### Introduction

Storytelling takes us beyond boundaries of culture, ethnicity, class, gender and language and can develop our ability to empathise with others whose lives seem different from our own. We sense what it is like to be in another person's skin, which is a step on the path to mutual understanding and constructive collaboration. We humans are storytelling beings, primed for telling and being told stories. The stories told among the world's oral cultures have been honed by communities over generations, drawing on collective experience to convey universal truths. When we are listening openly to a story, what we learn can go in deep.

As an English language teacher, you are an ideal classroom storyteller. You are well placed to select a story to suit your students and to modify the story as you tell it. Language learners find listening to a well-told story easier and more satisfying than less personal types of listening, because they are directly involved along with their teacher in imagining the story as it is told. In essence storytelling is a co-creative activity.

Every student in a group will have their own individual response to a story you tell according to factors including personal experience, cultural heritage, beliefs, mood and their relationship with you the storyteller as well as with other members of the group. Also, because storytelling is a communal activity, the group will have a collective response. Through simple and purposeful creative tasks following the storytelling, these personal and collective responses can be shared, leading to fresh insights and learning.

In this chapter I offer you four short and simple tales from the world's oral cultures. At their heart these stories are about making the world a better place. Each tale starts with a character stuck in a seemingly impossible situation and ends with the revelation of a possible way out. The tale is accompanied by creative tasks. Whether you teach adults, teenagers or children, you can adapt these stories and tasks to classes at different levels and of different sizes. No photocopying is required, so you only need to prepare to tell the story. Some teachers find the best

way to learn the story is to watch me telling it, so you can find a link to a video at the end of each activity. For some teachers it will be better to begin by reading through the transcript of me telling the story. Most teachers will find it useful to do both. Then practise telling the story to family, friends and colleagues or record and watch yourself telling the story until you feel ready to tell it to your students in your own words.

Through imagining and predicting before the storytelling, and doing drama, mental imagery, responding to metaphor and retelling tasks after the storytelling, your students can discover and voice their idea of a better world. These creative tasks are a powerful way to address challenging issues. They make it possible for students to develop their creativity, their critical-thinking skills and their self-expression, and to become more aware of their own attitudes and those of their fellow students. They also allow for a change in perspective. What students learn from a story is not what happens in the story but in their response to it, and students are fascinated to compare what they imagine and their own responses with their fellow listeners. This exchange deepens and enriches their own experience of the story. The insights at the end of the four wisdom tales in this chapter offer students a chance to explore and imagine what they can do personally to contribute towards making their communities and the world better.

### Activity 1: The Seed of Justice

#### Aim

- To emphasise that problems such as poverty, hunger, inequality and injustice are not insurmountable

#### Language focus

- Students will practise making predictions, listening to a story, acting out a dialogue, presenting a gift and exchanging personal stories.

## SDG focus

- SDG 1: No poverty, SDG 2: Zero hunger, SDG 10: Reduced inequalities, SDG 16: Peace, justice and strong institutions

## Creative focus

- Predicting the plot of a story, exploring key moments through drama and creating positive endings to personal stories of injustice

Level A2 to C2  
Age 8 years to adult  
Time 60 minutes

## Preparation

- Learn to tell the story.
- Bring a pear or show an image of a pear or draw a pear.

## Procedure

- Task before telling the story: show students a pear and get students to tell you that there are seeds inside. Let them know that you are going to tell them an old Chinese story called 'The Seed of Justice', in which a poor and hungry old man steals a pear and the Emperor has to judge him.
- Ask pairs to discuss what they think will happen in the story. This task introduces key vocabulary (pear, seed, justice, judge, emperor) and gets students thinking creatively before they listen.
- As you tell the story, address the students as if they are the Emperor's advisers. Imagine you are holding out the pear seed to them. Including students with eye contact and gestures brings them deeper into the storytelling.

## Follow-up

### Frozen images

- Invite students to make three different 'frozen images' from the story – the first two individually. You can give instructions like these:
  - o Stand up and make a frozen image of the old man eating the pear. Use your knees, your shoulders, your hands and let me see your eyes. Remember, you are so hungry ... 3–2–1 Freeze!
  - o Now you are the Emperor at the moment when the old man offers you the pear seed to plant. Remember all the times you lied and stole. Make a strong, still frozen image ... 3–2–1 Freeze!
  - o Now stand facing a partner. It is the end of the story. One of you is the old man who will explain that the seed is not magic and the other is the Emperor who will give the old man his freedom. Make a frozen image ... 3–2–1 Freeze!

## Improvised role play

- Ask students to keep the frozen image of the old man and the Emperor, and get ready to act out that scene using their own words. Encourage them to use their hands, faces, bodies and the voice of the old man and the voice of the Emperor.
- After the students have played the scene once, ask them to do the scene again. Point out that now they know what they are going to say, they can focus on listening to each other and taking turns to speak. Remind them to make sure their voices, facial expressions and actions are clear. They can start with their frozen image again.
- Invite one pair who have acted out the scene well to show it to the class. Before they start, ask the other students to notice what works particularly well in the pair's performance, and to be ready to tell them at the end. This will focus the listeners' attention, and the feedback at the end will give confidence to the two performers – and to the whole class.

## Choosing a gift

- Ask students to imagine that, at the end of the story, they can give any gift to the old man. They imagine their partner is the old man and give him the gift, saying why they are giving it.
- When the students have exchanged their gifts, find out about them. Some may be highly practical, such as a piece of farmland for the old man. Some may be symbolic, like a pear seed which is truly magical for the old man. Some may be conceptual, such as equal access to justice for the old man and all poor people.

## Personal storytelling

- Explain that one definition of justice is 'treating others with fairness and respect' and tell a story about injustice from your own experience.
- Ask students to think of a story of injustice from their own life experience outside of the class. Where did this happen? When did this happen? Who are the main people in the story? What happened? How did the people in the story feel? What happened in the end? Imagine a different ending. What would be a just ending to the story?
- Find out which students would like to tell their story to others in the class and group them accordingly. For example, if two-thirds of your students have a story to tell, put them in groups of three where each group has two storytellers, or if about a quarter of your students have a story, put them in groups of four with one storyteller in each group.
- Ask students to listen to each other's stories closely and, at the end, share their ideas about what would be a just ending to the story.



## Materials

### The Seed of Justice (China)

There was once a very poor old man. He had nothing. He went into the forest to collect firewood. He took the firewood to the marketplace to sell, so he could buy food. But nobody bought any of his firewood. He was so hungry. He looked at the fruit stall, at the ripe pears. He dreamed of eating one of those delicious-looking pears. Suddenly he found himself with a pear in his hand. He was eating it. The fruit seller shouted, 'Thief! You stole this pear. You took it without paying!'

The poor old man was taken to the Emperor who passed judgement on all the liars and thieves in his land.

'What did this man do?'

The fruit seller spoke. 'He stole one of my pears. He is a thief!'

The Emperor said, 'If you stole a pear, you are a thief. In my land all thieves must die.'

The poor, hungry old man held out his hand: 'Your Majesty, I have a gift for you. This seed is a magic seed. If this seed is planted in your garden, overnight a magic tree will grow. The magic tree will bear golden pears. It is a gift for you before I die.'

The Emperor was powerful and he was rich, but he wanted to be richer. He led the old man into the palace garden, along with all of his important advisers. The old man made a hole. Then he held out his hand again.

'Your Majesty, I cannot plant this magic seed, because I stole the pear and I am a thief. Only an honest man can plant this seed, only a person who has never lied and never stolen. Then the tree will grow overnight and bear golden pears. You plant it, your Majesty.'

The Emperor looked at the seed and he knew that he could not plant it. 'I am the Emperor, I am not a gardener. My adviser will plant it.'

The first adviser said, 'No, I am too important.' The second adviser said, 'I cannot do this.' Every adviser refused to plant the magic seed.

Finally, the poor old man held the seed out once more.

'Your Majesty, I lied. This seed is not a magic seed. I am a thief. I stole the pear. But I am not the only one who has lied and stolen. All of us have lied and stolen at some time in our life. I stole because I was hungry.'

The Emperor looked at the seed and said 'Old man, today you have taught me a lesson about justice. Go free.'

The old man went free and, from that time on, he always told the story about the just Emperor.

### Additional resources

The Seed of Justice

- This is a video recording of David Heathfield telling the story: <https://youtu.be/N-Rd4FoM4iQ>

## Activity 2: The Indian Bird

### Aim

- To enable students to express what freedom means to them

### Language focus

- Students will write definitions, describe mental imagery and write lines of poetry.

### SDG focus

- SDG 16: Peace, justice and strong institutions

### Creative focus

- Exploring and comparing mental imagery in response to being told a story and composing and displaying a poem about freedom

Level A2 to C2

Age 8 years to adult

Time 50 minutes

### Preparation

- Learn to tell the story.

### Procedure

- As a task before telling the story, let your students know that you are going to tell them a short Middle Eastern tale about freedom. Ask students to write their own definitions of freedom.
- While telling the story, try to make the voices of the bird and the rich man different from your narrator voice. Using direct speech adds immediacy and impact to your storytelling.

## Follow-up

### Mental imagery

- Ask students to sit quietly with their eyes closed. Guide them gently through this mental imagery activity, slowly reading aloud the script:
  - o You are the rich man walking through the Indian forest. You can feel the heat around you ... What smells are there? ... Listen, you can hear a bird calling. It sounds like the bird in your cage at home. What sound is it making? ... Walk towards the sound. Now you can see a tree with Indian birds sitting in the branches. How many birds can you see? How big are they? What do they look like? What colours are their wings and tails? Come closer to one of the birds. Can you describe what you see and hear in more detail? How are these forest birds different from your bird? How do you feel? Now open your eyes and sit quietly.
- Invite students in pairs to listen to each other's descriptions of the forest and the birds, noticing the similarities and differences in the way they imagined them. Then ask for comments from the whole class.

### Responding with poems

- Remind students of the definitions of 'freedom' they wrote. Invite them to think about freedom in their own lives, in the lives of others, in their own communities, in other communities and around the world.
- Ask them to write as many sentences as they like beginning 'Freedom is ...', each on a separate strip of paper.
- In small groups or individually, students select from their 'freedom' sentences and rewrite them as lines of 'freedom' poems. These can be displayed as large pieces of classroom wall art, each line written on a leaf-shaped piece of card on a branch of the Indian forest tree. The tree could have colourful Indian birds sitting in it.

## Materials

### The Indian Bird (Middle East)

Once there was a rich man who kept a beautiful Indian bird in a golden cage.

'I am going to India,' he said to the bird. 'What do you want?'

The bird said: 'All I want is to be free.'

'I can't give you that,' said the rich man. 'Ask for something else.'

The bird said, 'When you go to India, find other birds like me and tell them about me.'

'I agree.'

The rich man travelled to India. He went to the forest and came to a tree, where there were birds like his Indian bird with beautiful colourful feathers, sitting in the tree.

He said, 'Oh beautiful Indian birds, I have a bird like you and I keep it in a cage in my house.'

As he spoke, one beautiful bird fell from the tree onto the ground, lifeless.

'Oh no,' the rich man said. 'The bird is dead. The bird is heartbroken.'

He went home and into his house to the cage.

The Indian bird said, 'Did you tell them?'

'I did,' said the rich man, 'but when I told them, one beautiful bird fell from the tree, dead on the ground.'

As he said this, his Indian bird fell from his perch onto the floor of the cage, lifeless.

'Oh no, now my bird is heartbroken.' Sadly he reached into the cage and took the body of the Indian bird and put it by the window. When he put it by the window, the bird came back to life and flew out of the window, free.

This is how the bird in the forest taught the bird in the cage how to be free.

## Additional resources

The Indian Bird

- This is a video of David telling the story: [https://youtu.be/bV20\\_xXynB8](https://youtu.be/bV20_xXynB8)

## Activity 3: The Old Woman's Wish

### Aim

- To demonstrate that thinking creatively can bring rewards that surpass expectations and to raise awareness of a religion

### Language focus

- Students will discuss causes of a global problem, use target vocabulary while they paraphrase a story orally and make sentences beginning 'I wish ...'

### SDG focus

- SDG 3: Good health and well-being, SDG 5: Gender equality

### Creative focus

- Students predict the ending of a story, develop their storytelling skills and imagine solutions to a global problem.

Level A2 to C2

Age 8 years to adult

Time 50 minutes

### Preparation

- Learn to tell the story.
- Find an image of the Hindu god Lord Ganesh which you can show your students.

### Procedure

- Task before telling: agree as a class on one difficulty the world is facing (e.g. gender discrimination) and identify some of the main causes.
- Show students an image of the elephant-headed god Lord Ganesh and explain that Hindus believe he has the power to take away any difficulty. Tell them that you are going to tell a Hindu story about how Ganesh gave somebody one wish.
- While telling the story, stop just before the old woman makes her wish at the end of the story and find out what different students think she will say.

## Follow-up

### Student retelling

- Get students to remember key vocabulary from the story and display this list: lost her sight, make a wish, wealth, a grandchild, I wish I could see my grandchild drinking milk from a golden bowl.
- Sitting face to face in pairs, students retell the story. They can refer to the key vocabulary while telling the story in their own words.

### Personal response

- Ask students to discuss the meaning of the story in pairs, making it clear that there are no right or wrong answers.
- Students remember the difficulty and the main causes of the difficulty which they discussed before the story was told. The story suggests that the key to taking away a difficulty is to ask the right question. Ask students to write down the one wish they would make in order to take away the difficulty, beginning 'I wish ...'.
- Students share and compare and edit their wish in small groups and as a whole class until they are satisfied with their wish. You might find that you end up with one whole-class wish or some different ones.

### Sharing

- Encourage students to tell the story to people they know outside the class in English and in any other languages they speak. Remind them that each time they tell the story, their storytelling will get better.

## Materials

### The Old Woman's Wish (India)

There was once an old woman who had lost her sight. She was good. Every day she prayed to Lord Ganesh, who could take away any difficulty. One day Lord Ganesh appeared to the old woman.

'I will give you one wish. What do you wish for?'

The old woman said, 'I do not know. I need time.'

'Then ask your son and ask your daughter-in-law for their advice. I will come again.'

The old woman went to her son. 'What should I ask for from Lord Ganesh?'

'Mother, ask to be rich.'

She went to her daughter-in-law. 'What should I ask for from Lord Ganesh?'

'Mother-in-law, ask for a grandchild, because we don't have any children.'

The old woman listened and thought.

She went to her neighbour. Her neighbour asked what she was thinking about.

'I don't know whether to ask to be rich as my son wished, or to ask for a grandchild as my daughter-in-law wished.'

'They are only thinking of themselves,' said the neighbour. 'They are not thinking about you. You have many years left to live. I think you should ask for your sight.'

The old woman thought and thought and thought and the next day Lord Ganesh came back.

'Now it is time to make your wish. One wish. What do you ask for?'

'I am ready, Lord Ganesh, to make my wish. I wish to see my grandchild drinking milk from a golden bowl.'

Lord Ganesh laughed. 'You are clever. I give you your wish.'

So her son was happy and her daughter-in-law was happy and the old woman was happy.

## Additional resources

### The Old Woman's Wish

- Here is a video of David telling the story: <https://youtu.be/pMhT-y4UpFE>

## Activity 4: In Your Hands

### Aim

- To raise students' awareness of their potential to change the world

### Language focus

- Students will ask questions about the events of a story, tell a story, compare versions of a story and discuss metaphor.

### SDG focus

- SDG 4: Quality education, SDG 17: Partnerships for the Goals

### Creative focus

- Students ask about and imagine a story, respond creatively to metaphor through writing and drawing, and evaluate how they can make the world a better place.

Level A2 to C2

Age 12 years to adult

Time 30 minutes

### Preparation

- Learn to tell the story.

### Procedure

- Task before telling: ask students to discuss how often and how much they question or doubt what their teachers tell them.
- Let them know that you are going to tell them a short Middle Eastern tale about a teacher who can answer any question. Give them one minute to ask you questions about what happens in the story and answer them without giving away the ending.
- Ask students in pairs to tell the story as they imagine it.
- While telling: mime holding the bird in your hands, pressing it flat and setting it free as you tell the story. Miming actions can help students understand and imagine the story.

### Follow-up

Comparing with predictions

- Ask your students to talk in pairs about the similarities between the story they imagined beforehand and the story you told them.

Responding to metaphor

- Make sure every student has a piece of paper and ask them to spend five minutes alone, quietly responding to the metaphor in the final words of the story 'in your hands'. They can write and draw their responses.
- After five minutes, ask students to talk about their responses in groups of three or four, before sharing ideas as a class.

### Discussion

- These tasks can stimulate discussion and project work about the extent to which individuals are responsible for making their communities and the world a better place.

### Materials

#### In Your Hands (Middle East)

Once there was a teacher and this teacher could answer any question. Whatever the students asked the teacher, the teacher could give a wise answer. The students were tired of this.

'Let's ask a question that is impossible to answer.' So, together the students made a plan. One of the students caught a small bird and brought the small bird cupped in his hands to the teacher.

'Teacher, tell me. What I am holding in my hands, is it alive or is it dead?'

The teacher somehow knew that the student was holding a bird in his hands.

The teacher knew that if he said it was alive, the student would press the bird and show it was dead.

The teacher knew that if he said it was dead, the student would open his hands and the bird would fly away, alive.

The teacher looked at the student. 'The answer, life or death, is in your hands.'

### Additional resources

In Your Hands

- Here is a video of David telling the story: <https://youtu.be/ONRNOPJQn6s>

## Further reading

Gersie, A, Nanson, A and Schieffelin, E (2014) *Storytelling for a Greener World: Tales, Talks and Songs*. Hawthorn Press. This book contains inspirational chapters written by different UK-based storytellers who put sustainable development at the heart of their practice.

Heathfield, D (2014) *Storytelling With Our Students*. Peaslake: Delta Publishing. I wrote this book for teachers who want to develop themselves and their students as classroom storytellers.

Morgan, J and Rinvoluceri, M (1983) *Once Upon a Time*. Cambridge: Cambridge University Press. An excellent collection of story frameworks and ideas for using them.

Taylor, EK (2000) *Using Folktales*. Cambridge: Cambridge University Press. The book focuses specifically on the use of folktales and includes many ideas for using them in language teaching.

Teaching English – Rhythm, rhyme, repetition, reasoning and response in oral storytelling, Heathfield, D: <http://www.teachingenglish.org.uk/article/rhythm-rhyme-repetition-reasoning-response-oral-storytelling>. This article identifies some key storytelling techniques.

Teaching English – Storytelling to Celebrate Cultural Diversity, Heathfield, D: <http://www.teachingenglish.org.uk/article/storytelling-celebrate-cultural-diversity>. This article focuses on the value of sharing stories from diverse cultures.

Teaching English – Teaching the tale: language and memory, Heathfield, D: <http://www.teachingenglish.org.uk/article/teaching-tale-language-memory>. This article outlines an approach to teaching students to tell a tale.

Wajnryb, R (2003) *Stories*. Cambridge: Cambridge University Press. A collection of ideas for bringing narrative into the classroom and a story bank for teachers.

Wright, A (2009) *Storytelling with Children*. Oxford: Oxford University Press. A collection of stories and ideas for their exploitation with the emphasis on use with children. You can find me telling many more stories with learners of English on my YouTube storytelling channel: [www.youtube.com/channel/UCscW6lz3okT\\_y\\_69SsY0LGw?view\\_as=public](http://www.youtube.com/channel/UCscW6lz3okT_y_69SsY0LGw?view_as=public)

# 22

## Using the Sustainable Development Goals in the English for Academic Purposes classroom

Averil Bolster and Peter Levrai

### Introduction

This chapter will focus on activities based around the UN's Sustainable Development Goals (SDGs) 2030. These activities were designed to be used in the context of a general academic English course for undergraduate students.

Teaching and learning academic English is sometimes seen as 'dry' and not the most creative area of ELT. For pre-sessional and in-sessional undergraduate courses in English-speaking countries and English-medium instruction (EMI) universities in non-English speaking countries, finding topics that are relevant and appealing to students from a variety of disciplines can be a difficult task for course designers and teachers. The SDGs lend themselves to multidisciplinary study and can be approached through the lens of different fields of academic study, which makes them an excellent content area for an EAP course, engaging students intellectually, academically and emotionally.

Although the materials in this chapter were developed with mixed discipline groups in mind, they could also be used with a cohort of shared majors, which would allow for more discipline specific work. Despite the original concept of the activities in this chapter being for an EAP classroom, they could easily be used in a variety of contexts including general English courses for teenagers and adult learners and in business English classes.

While there are many definitions of creativity, we favour this one by Franken (as cited in California State University, Northridge, n.d.):

*Creativity is defined as the tendency to generate or recognize ideas, alternatives, or possibilities that may be useful in solving problems, communicating with others, and entertaining ourselves and others.*

The classroom activities in this chapter encourage looking at alternatives, problem-solving or communicating with others in some way. Most of the activities involve students working in pairs or small groups, as collaboration is also a key element in encouraging creativity, leading to the generation of new ideas. There are also creative ways to elicit ideas from students using a variety of online tools. We hope you and your will students enjoy them.

### Activity 1: Introducing the Sustainable Development Goals

#### Aim

- To introduce students to the UN's Sustainable Development Goals 2030

#### Language focus

- Oral fluency

#### SDG focus

- All

#### Creative focus

- Problem-solving

Level B2+

Age 16+

Time 60 minutes

#### Preparation

- You will need to create an AnswerGarden space for your students: <https://answergarden.ch/>.
- You will need to be able to access the video 'Home' from the UN SDG YouTube channel: <https://www.youtube.com/watch?v=7GjLa5kfDfA>.
- You will also need to make copies of Worksheet 1. If you have internet access in your classroom you could use this interactive quiz instead: [https://quizlet.com/\\_2m15kx](https://quizlet.com/_2m15kx).

## Procedure

- Ask students to think what the word 'home' means to them and what words come to mind.
- In pairs, students then discuss their ideas and add them to the group's AnswerGarden.
- Hold a whole-class discussion, drawing attention to the most popular answers in the AnswerGarden and some of the least popular.
- Tell students there is also another way to think about home.
- Play the 'Home' video.
- Ask students to contrast their ideas from the previous discussion with the ideas in the video.
- Explain that the SDGs involve 17 goals, and have students work in groups of three or four, matching the goals with the simplified definitions on Worksheet 1. This can also be done using the interactive quiz: [https://quizlet.com/\\_2m15kx](https://quizlet.com/_2m15kx).
- Ask students to choose three of the goals and then get them to brainstorm ways in which they, as individuals, could contribute towards those goals.
- Feedback can be done either as impromptu presentations or whole-class discussion.

## Follow-up

- Ask half of the class to read <https://theconversation.com/explainer-the-worlds-new-sustainable-development-goals-47262> and the other half of the class to read <http://www.theguardian.com/global-development/2015/jan/19/sustainable-development-goals-united-nations>. At the start of the next class, students explain the content of the articles to each other either in pairs or small groups.



## Materials

### Worksheet 1: SDG matching

Print the worksheet, cut up the icons and strips of paper and get students to match them.

 <p><b>1</b> NO POVERTY</p> 	 <p><b>2</b> ZERO HUNGER</p> 	 <p><b>3</b> GOOD HEALTH AND WELL-BEING</p> 
 <p><b>4</b> QUALITY EDUCATION</p> 	 <p><b>5</b> GENDER EQUALITY</p> 	 <p><b>6</b> CLEAN WATER AND SANITATION</p> 
 <p><b>7</b> AFFORDABLE AND CLEAN ENERGY</p> 	 <p><b>8</b> DECENT WORK AND ECONOMIC GROWTH</p> 	 <p><b>9</b> INDUSTRY, INNOVATION AND INFRASTRUCTURE</p> 
 <p><b>10</b> REDUCED INEQUALITIES</p> 	 <p><b>11</b> SUSTAINABLE CITIES AND COMMUNITIES</p> 	 <p><b>12</b> RESPONSIBLE CONSUMPTION AND PRODUCTION</p> 
 <p><b>13</b> CLIMATE ACTION</p> 	 <p><b>14</b> LIFE BELOW WATER</p> 	 <p><b>15</b> LIFE ON LAND</p> 
 <p><b>16</b> PEACE, JUSTICE AND STRONG INSTITUTIONS</p> 	 <p><b>17</b> PARTNERSHIPS FOR THE GOALS</p> 	

<b>To make sure everyone has enough money to live on</b>
<b>To make sure everyone has enough food to eat</b>
<b>To make sure everyone is healthy</b>
<b>To make sure everyone has access to good education throughout their lives</b>
<b>To make sure men and women have equal opportunities</b>
<b>To make sure everyone has access to clean water and cleaning facilities</b>
<b>To make sure everyone has access to affordable energy from a sustainable source, e.g. solar energy</b>
<b>To make sure everyone can get a good job with fair pay and the economy grows</b>
<b>To provide good infrastructure (e.g. transport networks) and encourage new ideas in industry</b>
<b>To make sure everyone has equal opportunities, regardless of their age, race, religion or where they live</b>
<b>To make cities and communities safe, sustainable places to live in</b>
<b>To make sure things are produced and used efficiently</b>
<b>To try and reverse the negative impact human action has had on the climate</b>
<b>To protect natural environments and endangered species</b>
<b>To make sure we use the seas sustainably, e.g. avoid overfishing</b>
<b>To create a peaceful world where everyone has access to fair justice</b>
<b>To encourage countries, corporations and communities to work together towards the SDGs</b>

## Activity 2: Reducing inequalities

### Aim

- To encourage students to think more deeply about the relative importance of selected SDGs

### Language focus

- Discussion strategies, e.g. expressing an opinion, justifying, agreeing/disagreeing

### SDG focus

- Sustainable Development Goals 2, 4, 6, 8, 10

### Creative focus

- New ways of expressing opinion and creating arguments in favour of a particular point of view

Level B2+

Age 16+

Time 40 minutes

### Preparation

- You will need to be able to access the video 'If the World were 100 people': <https://www.youtube.com/watch?v=QFrqTFRy-LU>.
- Prepare an online survey like: <https://goo.gl/forms/jXKgiT4XqZTN6ltX2> using Google Forms: <https://www.google.co.uk/forms/about/>, or use Worksheet 1 from the Materials section.

### Procedure

- Conduct a short in-class survey at the start of the lesson using Worksheet 1. Answers could be either written on the board or posted online using Google Forms (<https://goo.gl/forms/jXKgiT4XqZTN6ltX2>).
- Ask students to discuss in groups if they think these results are the norm.
- Monitor the discussion and make note of language they use to present opinions, agree/disagree with each other.
- Put the noted language of opinion and agreement on the board and elicit other ways students could express their opinions.
- Give students Worksheet 2: Discussion functions and ask them to add any new terms.
- Play the 'If the World were 100 People' video and make note of the facts the students find most surprising.
- Remind them to contrast the facts in the video with the answers they gave at the start of class.

- Discuss in pairs and small groups before whole-class feedback.
- Ask the students to watch the video again and identify which facts match with which of the SDGs on Worksheet 3:
  - o SDG 2: Zero hunger
  - o SDG 4: Quality education
  - o SDG 6: Clean water and sanitation
  - o SDG 8: Decent work and economic growth
  - o SDG 10: Reduced inequalities
- Divide the students into five groups and give each group one of the above SDGs.
- Tell them they are going to explain why their SDG is the most important.
- During preparation time, encourage students to consider what the other groups will say and come up with counter-arguments.

### Follow-up

- Students research to find evidence to support the arguments they made in class and write a paragraph explaining the importance of their goal.

### Materials

#### Worksheet 1: Survey

1. Do you have a mobile phone?
2. Do you have access to the internet at home?
3. Have you visited another country?
4. Do you expect to get an undergraduate degree?
5. Do you have a job?
6. Do you own a car?
7. Have you travelled by plane?
8. Is it easy to buy the food that you want?
9. Is it easy to see a doctor if you need to?
10. Is there any limit on how much water you can use at home?

## Worksheet 2: Discussion functions

<p><b>Giving an opinion</b>          I think ...          In my opinion ...          I would say ...          If you ask me ...          I tend to think ...          I feel that ...</p> <p><b>Asking for an opinion</b>          What do you think?          How about you?          What's your opinion?          What would you say?</p> <p><b>Interrupting</b>          Sorry, can I just say ...          Wait a minute.          Sorry, if I can stop you there, ...</p>	<p><b>Agreeing with an opinion</b>          Absolutely.          I couldn't agree more.          That's an excellent point.          I'd agree with that.          Me too.</p> <p><b>Qualified (dis)agreement</b>          Yes, but ...          That's true up to a point, but ...          That could be true. However, ...          That's interesting. You also need to consider ...</p> <p><b>Disagreeing with an opinion</b>          I don't think so.          How can you say that when ...?          Absolutely not.</p>
---	--

## Worksheet 3: SDG fact matching

Goal 4: Quality education	86 can read and write 7 attended college, 93 did not 44 have internet, 56 do not
Goal 8: Decent work and economic growth	15 people make less than \$2 per day 56 make between \$2 and \$10 per day 13 make between \$10 and \$20 per day 9 people make between \$20 and \$50 per day 6 people make between \$50 and \$90 per day 1 person makes more than \$90 per day
Goal 10: Reduced inequalities	1 person controls 50% than of all the money
Goal 6: Clean water and sanitation	87 have clean water, 13 do not
Goal 2: Zero hunger	21 overweight, 63 healthy, 15 malnourished, 1 starving

### Activity 3: Opening a presentation

#### Aim

- To help students to think of creative ways to begin oral presentations to engage the audience
- To give each student the opportunity to present a short opening to a presentation in a 'presentation rounds' activity

#### Language focus

- Pronunciation (sentence stress), public speaking

#### SDG focus

- Sustainable Development Goals 6, 3, 5, 13, 15, 12, 17

#### Creative focus

- Engaging ways to start oral presentations

Level B2+  
Age 16+  
Time 90 minutes

#### Preparation

- You will need to be able to access this video from YouTube: <https://www.youtube.com/watch?v=EIJ9HKWJtOg>.

#### Procedure

- Explain the importance of beginnings – new school, new class, new job, new relationship, an essay, etc.
- Stress the importance of presentation openings.
- Ask students if they think the presentation opening in Worksheet 1: Standard presentation opening is effective.
- Read the presentation opening in a dull and flat way.
- Discuss the importance of using your voice effectively in presentations and how your presentation voice is different from your normal speaking voice: everything is bigger – bigger stresses, longer pauses, higher volume. Read through the presentation openings again to demonstrate.
- Demonstrate the effect of stress on meaning using the sentence in Worksheet 2: Sentence stress.
- Put the students into pairs. Ask student A to present the sentence with stress on a particular word and student B to identify which word was stressed.

- Get the students to change roles.
- Ask a volunteer student to present the opening, stressing the words in bold using Worksheet 3: Standard presentation opening with stress.
- Ask students if they agree with where the stresses are and then practise in pairs, stressing the words they think are important.
- Explain that sounding interesting is important but it is also important to say something interesting at the start of a presentation.
- Introduce the ways to open a presentation and explain what the terms mean.
- Perform the presentation openings in Worksheet 4: Strategies to open a presentation, or play the video of presentation openings and ask students which they prefer.
- Discuss the merits and disadvantages they identify in each opening.
- Arrange the students in their presentation groups (three students per group).
- Explain that they are going to develop the opening of a one-minute long presentation about a different SDG. They need to plan it together and one of them needs to present it.
- Emphasise the importance of the opening being engaging for the audience.
- Show the first three presentation topics in Worksheet 5: Presentation rounds, and tell each group to choose one of them.
- Give the students ten minutes to prepare and practise the opening.
- Monitor the groups and ensure they are trying to develop interesting openings and are making use of their voice effectively.
- The presenter from each group then gives their opening, and after the first round discuss which openings were more effective and why.
- Show the next two presentation topics from Worksheet 5: Presentation rounds, and explain that a different student in the group has to present the opening.
- Repeat the preparation, monitoring, presentation rehearsal and evaluative discussion.

- Encourage students to try a different type of opening from the one they did in the first round.
- Show the final presentation from Worksheet 5: Presentation rounds and explain the final student has to present it.
- Repeat the preparation, monitoring, presentation rehearsal and feedback.

## Materials

### Worksheet 1: Standard presentation opening

Good morning, ladies and gentleman. My name is ... and today I'm here to talk to you about water and sanitation. Water is a very important part of our lives. We can live without food for over a month, but would die without water inside a week. We use water for drinking, cooking, cleaning and growing our food. It is one of the most important resources we have and it is vital that we make changes to the way we live to preserve the water we have.

### Worksheet 2: Sentence stress

We all need access to clean water.  
 We ALL need access to clean water.  
 We all NEED access to clean water.  
 We all need ACCESS to clean water.  
 We all need access to CLEAN water.  
 We all need access to clean WATER.

### Worksheet 3: Standard presentation opening with stress

Good MORNING, ladies and gentleman. My name is ... and TODAY I'm here to talk to you about WATER and SANITATION. Water is a VERY important part of our lives. We can LIVE without food for OVER a month, but would DIE without water INSIDE a week. We use water for DRINKING, COOKING, CLEANING and GROWING our food. It is one of the MOST important resources we have and it is VITAL that we make changes to the way we live to PRESERVE the water we have.

## Worksheet 4: Strategies to open a presentation

### Strategy 1 – the standard opening

Good morning, ladies and gentlemen. My name is ... and today I would like to talk about water and sanitation, which is a very important topic.

### Strategy 2 – the question

Good morning, ladies and gentlemen. My name is ... Do you think water and sanitation are important?

### Strategy 3 – the prop

Good morning, ladies and gentlemen. My name is (cough, cough). Sorry. (Drink water) That's better. My name is ... (Look at water) You know, water is such a simple thing, many of us take it for granted. But it's really something we need to pay a lot more attention to. And that's what I'd like to talk to you about today – water and sanitation.

### Strategy 4 – the anecdote

Good morning, ladies and gentlemen. My name is ... and last week I had a really bad day. When I got up there was no water. That meant I couldn't have a shower, couldn't have a cup of coffee. I had to go to the shop to buy a bottle of water just so I could brush my teeth. As I was walking to the shop I got more and more annoyed at the inconvenience of it all and then I thought, how many people have to deal with that situation every day. How many people wake up without water? How many people have to walk, for miles, just to get water from a well? How many people may be forced to drink unsafe water because it is either unsafe water or no water at all? And the answer is ... too many. According to the UN, 783 million people do not have access to clean water and almost 2.5 billion, that's a third of the world's population, don't have adequate sanitation. The UN estimates that 6 to 8 million people die each year from the consequences of disasters and water-related diseases. And that's what I'd like us to talk about today – water and sanitation.

### Strategy 5 – statistics

Good morning, ladies and gentlemen. My name is Peter and before we begin today I would like you to think about some numbers. 71%, 2.5%, 0.3% and 99%. According to the USGS, 71% of the world's surface is covered in water. That's an incredible amount of water. However, the USGS goes on to point out the vast majority of water is salt water in the oceans. Only 2.5% of the world's water is fresh. That's still a lot of water but as the National Geographic points out only 0.3% of the world's fresh water is accessible. Most fresh water is trapped as ice or is deep underground. This means, although the world is covered in water, 99% of it is unusable. 99%.

## Worksheet 5: Presentation rounds

### Round 1

- Good health and well-being
- Gender inequality
- Climate action

### Round 2

- Responsible consumption and production
- Life on land

### Round 3

- Partnerships for the goals

## Additional resources

### The Conversation

- This is a news site in which content is developed by academics and is shared under the Creative Commons so articles can be republished unchanged if the site and author are credited. There is a section of the site specifically concerning the UN's SDGs: <https://theconversation.com/au/topics/un-sustainable-development-goals-11649>

### The Guardian newspaper

- The online version has a section dedicated to the SDGs: <https://www.theguardian.com/global-development/sustainable-development-goals>

## How can we engage our students with key global issues without placing the weight of the world upon them?

This is the key question which this publication answers by addressing the UN Sustainable Development Goals (SDGs) from a pedagogical perspective. Authors from across the world have created a series of engaging and enjoyable classroom activities which address each of the 17 goals. This publication has a twofold aim – to help students learn a language creatively whilst at the same time raising awareness of the SDGs through bringing together a range of innovative ideas for teaching creatively and addressing these key issues.

This publication follows on from the highly successful 'Creativity in the English language classroom' which was also edited by Alan Maley and Nik Peachey. Building on the success of the previous book, Maley and Peachey have skilfully selected activities which take the creativity agenda one step further by linking it to the SDGs.

## About the editors

**Alan Maley** has been involved with English language teaching for over 50 years. He worked with the British Council for 26 years (1962–88) in Yugoslavia, Ghana, Italy, France, China and India. He then resigned to take over as Director-General of the Bell Educational Trust in Cambridge (1988–93).

He was Senior Fellow at the National University of Singapore (1993–98) before going on to set up a new MA programme at Assumption University, Bangkok (1999–2004). He has since held university positions in Malaysia and Vietnam.

He is now a freelance trainer, writer and consultant. He has published over 50 books and numerous articles. He is a past President of IATEFL and recipient of the ELTons Lifetime Achievement Award (2012). He is also a co-founder of the C Group (<http://thecreativitygroup.weebly.com>). In 2015 he co-edited, with Nik Peachey, the highly successful companion volume to this book – *Creativity in the English language classroom*.

**Nik Peachey** is a freelance teacher trainer, writer, conference speaker and learning technology consultant. He has been involved in education since 1990 and has lived and worked all over the world. He is a two-time British Council Innovations Award winner and the co-founder of PeacheyPublications.com.

He has worked with a wide range of educational companies, publishers and institutions, including Macmillan, Cambridge University Press, Oxford University Press, The British Council, International House, Bell Educational Services, University of Westminster, The Open University, BBC, Google Creative Labs and many more.

Nik is a keen blogger and content curator. You can find his blogs at: <https://nikpeachey.blogspot.co.uk/> and <http://quickshout.blogspot.co.uk/> and his curation sites at: <http://www.scoop.it/t/tools-forlearners> and <http://www.scoop.it/t/learningtechnology>

He also publishes a twice-monthly Learning Technology and ELT newsletter at: <https://tinyletter.com/technology/>

In 2015 he co-edited, with Alan Maley, the highly successful companion volume to this book – *Creativity in the English language classroom*.

All photos in Chapters 10 and 11 courtesy of Malu Sciamarelli

[www.teachingenglish.org.uk/publications](http://www.teachingenglish.org.uk/publications)

ISBN 978-0-86355-855-9

© British Council 2017 / F003

The British Council is the United Kingdom's international organisation for cultural relations and educational opportunities.